



ES100A series compacted vectorial inverter

User Manual

**SHENZHEN DIRISE ELECTRIC TECHNOLOGY CO.,LTD
DONGGUAN DIRISE ELECTRIC EQUIPMENT MANUFACTURING CO.,LTD**

Introduction

Thank you for choosing DIRISE ES100A series compacted vectorial inverter.

ES100A series compacted vectorial inverter employs the modular functional design concept ,which can provide special solution for industrial demands.

Please read ES100A series manual carefully during using this inverter to make sure correct operation .This manual includes operation description and consideration for use .Incorrect use may cause unexpected accidents .This manual is an attachment sent randomly .Please store it properly for maintenance in the future.

Though we have examined the consistency of content with software and hardware during review, there may still be some contradictories and mistakes ,which will be revised in future versions. Should there be any information changed in the future, we won' t provide extra notices. We sincerely welcome any suggestions for improvement.

Must-Know in Use:

This product' s safe operation depends on correct installation, operation ,transport and maintenance. Please read this manual carefully and pay attention to hint about safe aspect.

- Use after knowing sufficient understanding of inverter ,safe information and all precautions.
- This manual should store in actual user.
- This manual has defined safety level as ‘Danger’ and ‘Warning’ which respectively use following sign:

 危険
DANGER : Risk of serious damage due to false operation .

 注意
WARNING : Risk of medium hurt ,injury or property loss due false operation.

Please obey the content marked with safety sign. Because of the different situations, ‘Warning’ level’ s items may cause serious consequence. Please obey the warning item mentioned above .

version 1.5
Revision Date:4,2021

Contents

Introduction	1
Contents	2
Out of Box Audit(OOBA)	4
Chapter 1 Safety Precautions	5
1.1 installation	5
1.2 Wiring	5
1.3 Operation	5
1.4 Maintenance	6
1.5 Disposal	6
1.6 Applicable scale of product	6
Chapter 2 Product information	7
2.1 Check when product delivery	7
2.2 Model description	7
2.3 Nameplate description	8
2.4 ES100A series inverter	8
2.5 Dimension	10
2.6 Product features	12
2.7 Technical specification	12
2.8 Installation dimension of operation keypad	14
Chapter 3 Mechanical and electric installation	15
3.1 Mechanical installation	15
3.2 Electric wiring	17
Chapter 4 Keypad operation	29
4.1 Keypad Introduction	29
4.2 Keypad display	31
4.3 Keypad operation	31
Chapter 5 Function Parameter Table	34
Chapter 6 Parameter Description	50
Group P00 basic parameters	50
Group P01 start / stop control	56
Group P02 motor parameters	60

Group P03 V/F control parameter group	61
Group P04 input terminal control	63
Group P05 output terminal control	69
Group P06 auxiliary parameters	72
Group P07 communication function	73
Group P08 PID control function	75
Group P09 simple PLC function	78
Group P10 fault and protection	80
Group P11 control parameters	82
Group P12 keypad and display	85
Group P15 torque control	87
Chapter 7 Fault diagnosis and elimination	90
7.1 Alarm and solution	90
7.2 Fault record inquiry	92
7.3 Fault reset	92
Chapter 8 Electromagnetic compatibility guidance	93
8.1 Definition	93
8.2 EMC standard introduction	93
8.3 EMC guidance	93
Chapter 9 Description of optional Accessories	97
9.1 Description selection of braking resistor	97
Appendix A ModBus Communication Protocol	98
1 Introduction	99
2 Serial port data format	99
3 Protocol frame format	99
4 ES100ASupported function codes	99
5 Mapping range of communication register	103
6 Communication error	104

Out of Box Audit (OOBA)

Before the product manufacture and package, our company has made a serious QC inspection .If any miss is found ,please make a contact with us, branch office or distributor as soon as possible .We will devote to constant optimizing and improving our product. If it is necessary to make any required modification, we will update the manual or provide corrigenda without extra notice.

Please check the following items when arrival:

- * Whether the product package is damaged
- * Read the data on nameplate to confirm the type and specification of product are in accordance with your order.
- *Check the period of inventory

Chapter 1 Safety Precautions

You must carefully read the following contents before installation, wiring, operation and maintenance of the product, and operate strictly according to notes.

1.1 Installation



- Please install the inverter on a nonflammable metal, lest there may be a risk of fire.
- Must not install the inverter in the environment containing combustibles or explosive gases. otherwise, there may be a risk of explosion.



- Install the inverter on a strong and reliable object which can stand the weight of inverter. otherwise, there may be a risk of fall or damage.
- Prevent any metal object from falling inside the inverter, otherwise, there may be a risk of accident.
- Do not try to install or run a damaged inverter, otherwise, there may be a risk of accident.

1.2 Wiring



- Must connect a proper circuit-breaker which matches capacity of the inverter on the input power side of the inverter. Otherwise, human injury, equipment damage or other accident may occur.
- Must ground PE terminal of inverter reliably, otherwise, it may cause electric shock or fire.
- Power source input terminal and motor output terminal must be tightened by bolts, otherwise, it may cause a fire.
- Wiring must be charged by professional.
- The wiring must be done after the power is cut off and the high-voltage indicator extinguishes.



- The input power must conform to the specifications on the nameplate. Otherwise, the inverter may be damaged.
- Never connect the output terminals (U, V, W) to the input power. Otherwise it may destroy the inverter.

1.3 Operation



- Only when the cover board has been attached, the power can be switched on. Otherwise, there may be a risk of electric shock.
- Do not touch main circuit terminal of the inverter when inverter is powered even if the inverter is in stop state. Otherwise, there may be a risk of electric shock.



- Use the “STOP/RESET” key on operation panel or external control terminal to stop the inverter, but not to break the main power supply. Otherwise, the inverter may be damaged.

1.4 Maintenance



- Must not carry out troubleshooting or maintenance until internal charge lamp is off or 10 minutes after power cut. Otherwise, there may be a risk of electric shock or injury.
- Maintenance of machine is for qualified personnel only, otherwise, it may cause electric shock or casualties.



- Make sure not to leave any electric conductor inside machine after maintenance, otherwise, it may cause damage.
- For the inverter left unused for a long time, internal capacity must be charged before use. Input voltage must be raised slowly by a voltage regulator (must not exceed rated input voltage of inverter), otherwise, there is risk of accident.

1.5 Disposal



- When the product is discarded, dispose it as an industrial waste. Otherwise, accident may occur.

1.6 Applicable scope of product



- Not applicable to the machine or system which may cause life danger of human.
- If a serious accident or loss can be predicted due to abnormality of product, please be sure to install additional safety devices.

Chapter 2 Product Information

2.1 Check upon delivery

Please check the following items when the inverter is firstly packed:

- ◆ Whether the product is damaged during shipping.
- ◆ Read data on the nameplate to conform whether type and specification of the product is in accordance with your order.
- ◆ Check whether the accessories shipped together with the inverter are complete.

The product is developed and manufactured in strict accordance with ISO9001. If any abnormality is found, please contact our agent or distributor as soon as possible.

2.2 Model Description

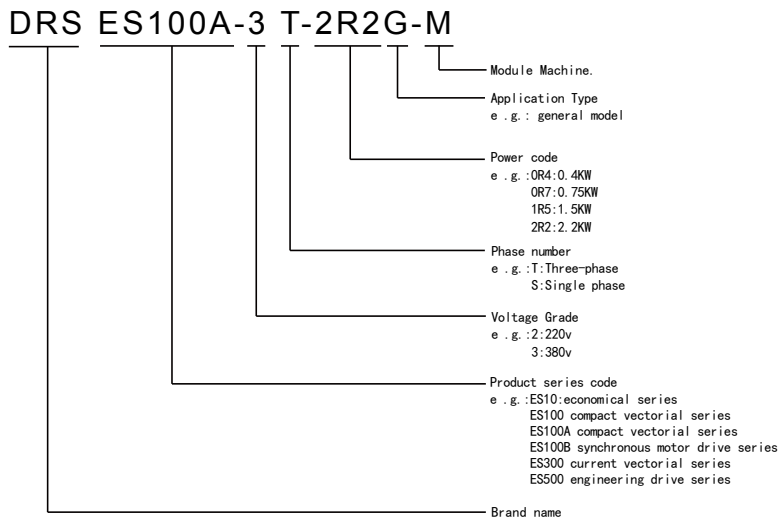

Fig2-1 Model description

2.3 Nameplate description

There is a nameplate indicating machine model and rated value at the bottom of right-side plate of inverter housing .The content of nameplate is shown as follow diagram.

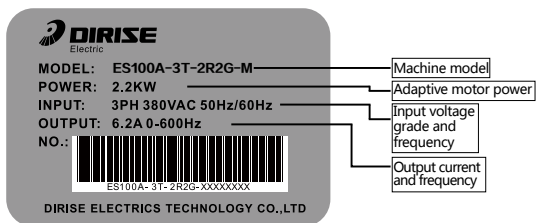

Fig2-2 Nameplate

2.4 ES100A series inverter

Table 2-1 ES100A series inverter model

Voltage grade	Product model	Adaptive motor(KW)	Rated output current(A)
Single phase 220V	DRS ES100A-2S-0R4G	0.4	2.8
	DRS ES100A-2S-0R7G	0.75	4.8
	DRS ES100A-2S-1R5G	1.5	8.0
	DRS ES100A-2S-2R2G	2.2	10.0
	DRS ES100A-2S-0R4G-M	0.4	2.8
	DRS ES100A-2S-0R7G-M	0.75	4.8
	DRS ES100A-2S-1R5G-M	1.5	8.0
	DRS ES100A-2S-2R2G-M	2.2	10.0
	DRS ES100A-2S-4R0G	4.0	17
Three-phase 220V	DRS ES100A-2T-0R4G	0.4	2.8
	DRS ES100A-2T-0R7G	0.75	4.8
	DRS ES100A-2T-1R5G	1.5	8.0
	DRS ES100A-2T-2R2G	2.2	10.0
	DRS ES100A-2T-0R4G-M	0.4	2.8
	DRS ES100A-2T-0R7G-M	0.75	4.8
	DRS ES100A-2T-1R5G-M	1.5	8.0
	DRS ES100A-2T-2R2G-M	2.2	10.0
	DRS ES100A-2T-4R0G	4.0	17
	DRS ES100A-2T-5R5G	5.5	25
DRS ES100A-2T-7R5G	7.5	32	

Three-phase 220V	DRS ES100A-2T-011G	11	45
	DRS ES100A-2T-015G	15	60
	DRS ES100A-2T-018G	18	75
	DRS ES100A-2T-022G	22	90
	DRS ES100A-2T-030G	30	110
	DRS ES100A-2T-037G	37	150
	DRS ES100A-2T-045G	45	176
	DRS ES100A-2T-055G	55	220
	DRS ES100A-2T-075G	75	260
	DRS ES100A-2T-090G	90	310
Three-phase 380V	DRS ES100A-3T-0R7G	0.75	2.8
	DRS ES100A-3T-1R5G	1.5	4.8
	DRS ES100A-3T-2R2G	2.2	6.2
	DRS ES100A-3T-4R0G	4.0	9.2
	DRS ES100A-3T-0R7G-M	0.75	2.8
	DRS ES100A-3T-1R5G-M	1.5	4.8
	DRS ES100A-3T-2R2G-M	2.2	6.2
	DRS ES100A-3T-4R0G-M	4.0	9.2
	DRS ES100A-3T-5R5G	5.5	13
	DRS ES100A-3T-7R5G	7.5	17
	DRS ES100A-3T-011G	11	25
	DRS ES100A-3T-015G	15	32
	DRS ES100A-3T-018G	18	38
	DRS ES100A-3T-022G	22	45
	DRS ES100A-3T-030G	30	60
	DRS ES100A-3T-037G	37	75
	DRS ES100A-3T-045G	45	90
	DRS ES100A-3T-055G	55	110
	DRS ES100A-3T-075G	75	150
	DRS ES100A-3T-090G	90	176
DRS ES100A-3T-110G	110	220	
DRS ES100A-3T-132G	132	260	
DRS ES100A-3T-160G	160	310	

2.5 Dimensions

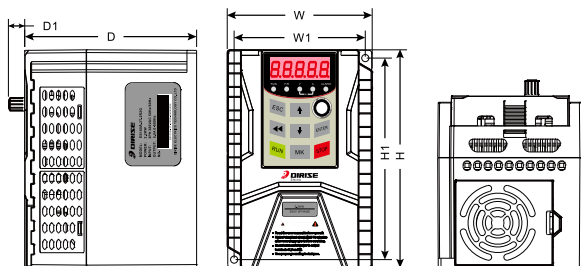

Apply to power: 0.4KW-15KW

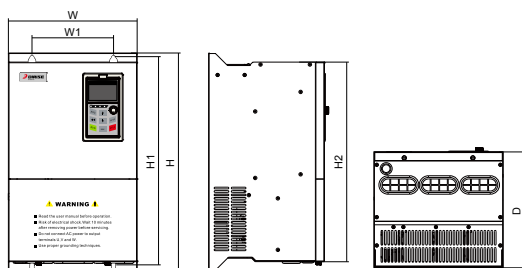

Apply to power: 18.5KW-160KW

Table 2-2 Dimension

Voltage grade	Product model	W (mm)	W1 (mm)	H (mm)	H1 (mm)	H2 (mm)	D (mm)	Installation hole (mm)
Single phase 220V	DRS ES100A-2S-0R4G	105	95	158	146		125	5.0
	DRS ES100A-2S-0R7G							
	DRS ES100A-2S-1R5G							
	DRS ES100A-2S-2R2G							
	DRS ES100A-2S-0R4G-M							
	DRS ES100A-2S-0R7G-M							
	DRS ES100A-2S-1R5G-M							
	DRS ES100A-2S-2R2G-M							
DRS ES100A-2S-4R0G	140	124	225	209		154		
Three-phase 220V	DRS ES100A-2T-0R4G	105	95	158	146		125	5.0
	DRS ES100A-2T-0R7G							
	DRS ES100A-2T-1R5G							

Three-phase 220V	DRS ES100A-2T-2R2G	105	95	158	146		125	5.0
	DRS ES100A-2T-0R4G-M							
	DRS ES100A-2T-0R7G-M							
	DRS ES100A-2T-1R5G-M							
	DRS ES100A-2T-2R2G-M							
	DRS ES100A-2T-4R0G	140	124	225	209		154	5.5
	DRS ES100A-2T-5R5G	160	143	265	248		170	
	DRS ES100A-2T-7R5G	205	140	344	328	320	205	6.5
	DRS ES100A-2T-011G							
	DRS ES100A-2T-015G							
	DRS ES100A-2T-018G	230	220	445	434	425	215	6.5
	DRS ES100A-2T-022G							
	DRS ES100A-2T-030G	300	190	505	483	465	270	9.0
	DRS ES100A-2T-037G							
	DRS ES100A-2T-045G	340	220	600	585	570	305	9.0
	DRS ES100A-2T-055G							
DRS ES100A-2T-075G	380	220	680	665	645	305	9.0	
DRS ES100A-2T-090G								
DRS ES100A-2T-090G	480	390	870	845	810	385	13	
Three-phase 380V	DRS ES100A-3T-0R7G	105	95	158	146		125	5.0
	DRS ES100A-3T-1R5G							
	DRS ES100A-3T-2R2G							
	DRS ES100A-3T-4R0G							
	DRS ES100A-3T-0R7G-M							
	DRS ES100A-3T-1R5G-M							
	DRS ES100A-3T-2R2G-M							
	DRS ES100A-3T-4R0G-M	140	124	225	209		154	5.5
	DRS ES100A-3T-5R5G							
	DRS ES100A-3T-7R5G							
	DRS ES100A-3T-011G	160	143	265	248		170	6.5
	DRS ES100A-3T-015G							
	DRS ES100A-3T-018G	205	140	344	328	320	205	6.5
	DRS ES100A-3T-022G							
	DRS ES100A-3T-030G	230	200	445	434	425	215	6.5
	DRS ES100A-3T-037G							
	DRS ES100A-3T-045G	300	190	505	483	465	270	9.0
	DRS ES100A-3T-055G							
	DRS ES100A-3T-075G	340	220	600	585	570	305	9.0
	DRS ES100A-3T-090G							
DRS ES100A-3T-110G	380	220	680	665	645	305	9.0	
DRS ES100A-3T-132G								
DRS ES100A-3T-160G	480	390	870	845	810	385	13	

This table provides standard product dimension of our company and some product may be different. Should there be any change because of product updated, notice will not be extra provided.. Please contact us for details.

2

2.6 Product features

- 1.Capable to provide industry professional solutions and make secondary development as required.
2. Application of special control chip in motor and advanced optimized magnetic flux vector control algorithm make better operation performance.
- 3.Standard LED keypad and flexible multi-channel monitoring parameters
- 4.6-CH can programme multi-functional input terminal ,2-CH can programme multi-functional open collector and relay output.1-CH programmable relay output.
- 5.2-CH analog signal (0 ~ +10V、 0 ~ 20mA) input channel and 1-CH voltage analog signal output channel .
- 6.External terminal can choose 7 section and programme multi-speed operation.
- 7.Standard configuration enhanced PID adjustor facilitates user' s close loop control such as temperature ,pressure and flux.
- 8.Standard built-in braking unit ,dynamic braking initial voltage and braking action rate can be flexibly adjusted according to requirement.
- 9.Standard RS485 port can be chosen to relaxed achieve the connection of PLC,IPC and other industrial devices .It can also achieve multi-inverter's linkage operation.
- 10.More than 20 kinds of protect function like Input phase-loss, output phase-loss, overcurrent ,overload and output short circuit can provide speedy and efficient protection for inverter and motor.

2.7 Technical specification

Table 2-3 Technical specification

Function description		Specification index
Power input	Rated input voltage	Single phase 220V \pm 20% Three Phase 220V \pm 20% Three Phase 380V \pm 20%
	Rated input frequency	50 ~ 60Hz (\pm 5%)
Power output	Rated output voltage	Maximum output voltage of rated output voltage is same as input power source and voltage
	Rated output current	100%rated current continuity output
	Maximum overload current	150% of rate current for 1 minute ,180% of rated current for 10 seconds

Control function	Control ways	open loop vector ,SVC vector control
	Maximum frequency	600.00Hz
	Frequency resolution ratio	Given digital: 0.01Hz Simulation given:Maximum frequency × 0.1%
	Adjustable velocity range	1:50 (open loop vector) 、 1:100(SVC)
	Steady velocity precision	± 0.2% rated synchronous speed
	Torque boost	Fixed torque boost curve 、 random V/F curve can be chosen
	Acceleration/Deceleration curve	Straight line and S curve
	Acceleration/Deceleration time	0.01S ~ 600.00S
Control function	Automatic voltage adjusted	When network voltage varies, it can automatically maintain constant output voltage.
	Overcurrent, and voltage stall	Automatic limitation of current and voltage during operation to prevent frequent overcurrent overvoltage tripping.
	Automatic current limiting	Automatic limit output current in order to avoid frequent overcurrent trip .
	DC braking	DC braking frequency:0.10Hz~upper limit frequency Braking time: 0.00S ~ 30.00S Braking action current value: 0.00% ~ 150.00%
	Signal input source	communication,multi-speed , analog value and so on
Peripheral interface	External power source	10V/10mA 24V/150mA
	Digital input	6-CH can programme input terminal (X1-X6)
	Digital output	1-CH can programme Y1 terminal output and relay output R1
	Analog input	AI:0~10V voltage input AI:0~10v/0~20mA input
	Analog output	AO:0~10V output
	485 communication	Support standard Modbus communication protocol
Operation keypad	LED Display	5 bit Nixie tube Display
	Keys	8 operation keys
Protection	Fault protection function	Input phase loss, output phase loss, overcurrent protection, overvoltage protection, under-voltage protection, over-heated protection, overload protection
Envi- ronment	Installation site	Indoor environment free from direct exposure to sunlight, dust, corrosive gases, combustible gases, oil mist, vapour, water drop or salt.
	Altitude	Lower than 1000 meters
	Ambient temperature	-10℃ ~ +40℃

2.8 Installation Dimension of Operation Keypad

Label	W	W1	W2	H	H1	H2	D	D1
Size(mm)	55.0	51.6	42.0	85.0	81.6	72.0	13.5	11.0

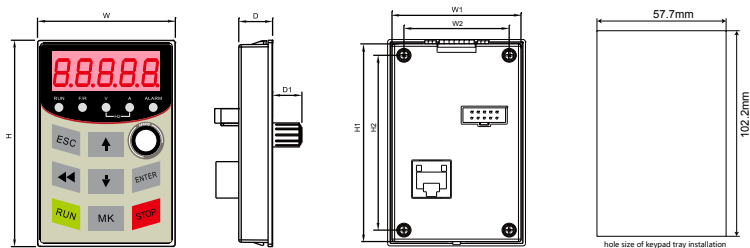

Suitable for 0.4~15KW model

Label	W	W1	H	H1	D
Size(mm)	77	36.5	136	114	17

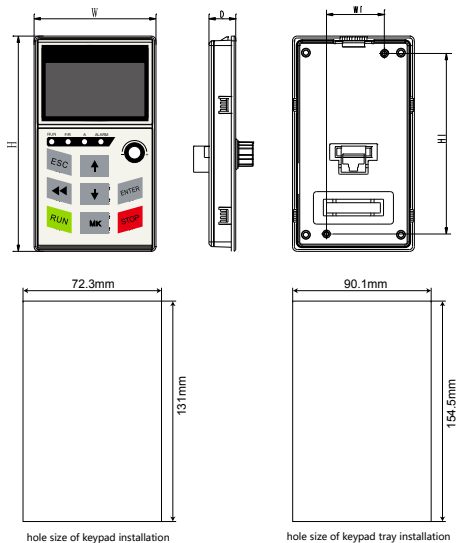

Suitable for 18.5~160KW model

ig 2-3 The diagram of Keypad size and Keyboard Tray size (Unit:mm)

Chapter 3 Mechanical and electric installation

3.1.1 Mechanical installation

3.1.1 Ambient condition

Environment temperature range of using inverter: $-10^{\circ}\text{C} \sim 50^{\circ}\text{C}$. When the ambient temperature is higher than 50°C , please choose a well ventilated place and derate the output of inverter by 10% for every 5°C increment.

3.1.2 Installation site

- ◆ No corrosive, flammable or explosive gases or liquids;
- ◆ Humidity: less than 90% RH, no condensation;
- ◆ Vibration: less than $5.9\text{m}/(0.6\text{g})$;
- ◆ Avoid installing it at a place with much dust and metal powder;

If users have special installation requirements, please consult and confirm with manufacturer in advance.

3.1.3 Installation Precautions

During installation, please take effective precautions to keep metal scraps, dusts or powders from falling into inverter. After installation, please take protective tools away.

3.1.4 Installation interval and heat dissipation

Wall-mounted type is recommended for installation. Installation interval and required distance of single inverter is shown in Fig 3-1. If two inverters are installed above and below, they should be installed with spacer in the middle, as shown in Fig 3-2.

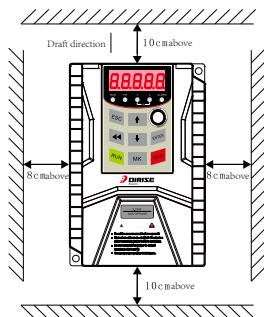

Fig 3-1 Installation interval distance diagram

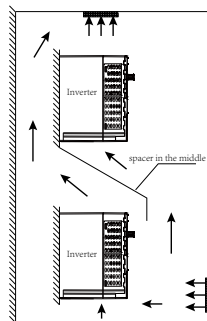

Fig 3-2 installation diagram of multiple inverters



- ◆ High temperature may shorten the service life of inverter.
- ◆ If there is heating device near inverter, please keep it as far as possible. When inverter is fixed inside a cabinet, sufficient consideration should be given to the perpendicularity and space size in order to help with heat dissipation.

3.1.5 Screw fixation and installation method

The product is installed by two holes in opposite corners. Size of installation hole should be subjected to housing dimension and installation dimension. Make 2 holes on installation surface, align inverter with the holes, insert bolts and tighten the bolts. The screw choose combined screw with spring washer and flat pad. (Length 12 mm, locking torque $1\text{Nm} \pm 10\%$). Installation method is shown in Fig 3-3.

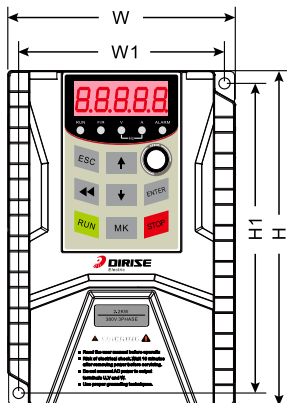

Fig 3-3 Screw fixation and installation method

3.1.6 Disassembly and installation of keypad

A. Method of keypad disassembly is shown as fig 3-4: press keyboard elastic clasp in direction 1 and lift keypad in direction 2.

B. Method of keypad installation is shown as fig 3-5: Flat the keypad into the keypad slot and press the keypad in direction 1 until you hear the ‘clicking’ sound, namely the keypad is flush with the front of machine surface.

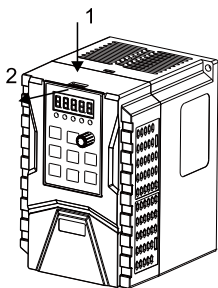

Fig 3-4 Keypad disassembly

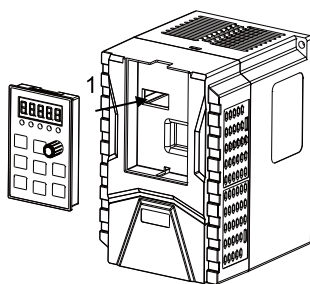

Fig 3-5 Keypad installation

3.1.7 Disassembly and installation of terminal cover

A. Method of terminal cover disassembly is shown as fig 3-6:press terminal cover card position in direction 1 and remove terminal cover in direction 2.

B. Method of terminal cover installation is shown as fig 3-7 :install the upper card buckle of terminal cover into the corresponding junction of upper shell.Press the buckle on the side of the cover in direction 2, and finally in direction 3 until you hear "snap" at the joint.

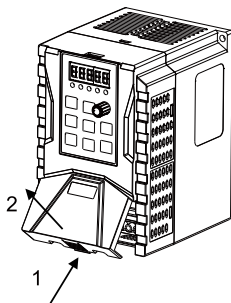

Fig 3-6 Terminal cover disassembly

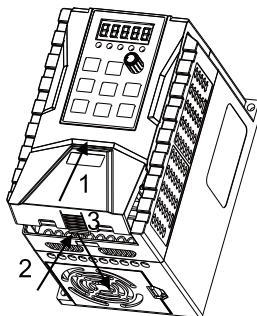



Fig 3-7 Terminal cover installation

3.2 Electric wiring

After opening terminal cover, a terminal strip is revealed. Check if terminals of main circuit and control circuit are clear. Pay attention to the following instructions in wiring:

1. Power supply terminals of main circuit R/L1,S/L2 and T/L3 are input power terminals. If power supply were mistakenly connected to other terminals, the inverter would be burnt out. Make sure power supply is within rated voltage/current labeled on nameplate.
2. Grounding terminals must be well connected. Reliable connection may prevent electric shock or fire accident, and reduce noise.
3. Please make sure connection terminals and leads are reliably locked lest sparks would be caused due to loose connection.
4. Electriferous operation is forbidden for control terminals.

 危险 DANGER	<ol style="list-style-type: none"> 1. Before connection, please make sure input power source is cut off, otherwise, there is risk of electric shock and fire. 2. Connection operation should be for electric engineering technicians only, otherwise, there is risk of electric shock and fire. 3. Grounding terminals must be reliably grounded, otherwise, there is risk of electric shock and fire. 4. After emergency stop button is connected, must check if action is effective, otherwise, there is risk of injury (connection liability should be undertaken by user). 5. Must not directly contact the terminals. Inverter terminals must not be connected to housing and short circuit between terminals is forbidden, otherwise, there is risk of electric shock and short circuit.
 注意 WARNING	<ol style="list-style-type: none"> 1. Please confirm if voltage of AC power is consistent with rated voltage of inverter, otherwise, there is risk of injury and fire. 2. Voltage proof test is forbidden for inverter, otherwise, it would damage semiconductor components inside inverter. 3. Please connect braking resistor or braking unit according to connection diagram, otherwise, there is risk of fire. 4. Please use specified torque to screw up terminals with screw driver, otherwise, there is risk of fire. 5. Do not connect power cord to terminal U, V and W. When voltage is imposed on output terminals, inverter will be damaged from inside. 6. Must not connect phase-shifting capacitor and LC/RC noise filter to output circuit, otherwise, inverter would be damaged from inside. 7. Must not connect any switch or contactor to output circuit. When inverter runs with load, switch and contactor action will create surge current and surge voltage resulting in damage of inverter. 8. Must not disassemble connection cables inside inverter, otherwise, there is risk of damaging inverter.

3.2.1 Connection configuration of peripheral equipment

Fig 3-8 Wiring diagram of ES100A series inverter and peripheral devices;

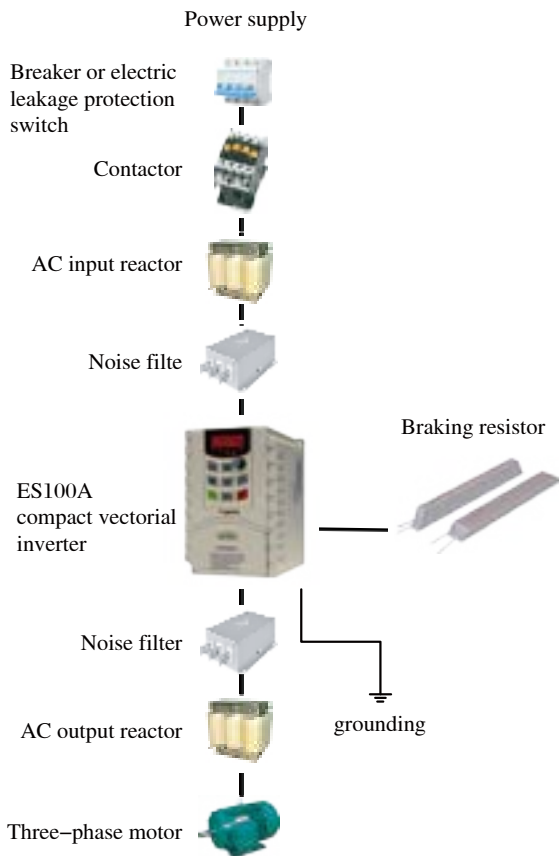
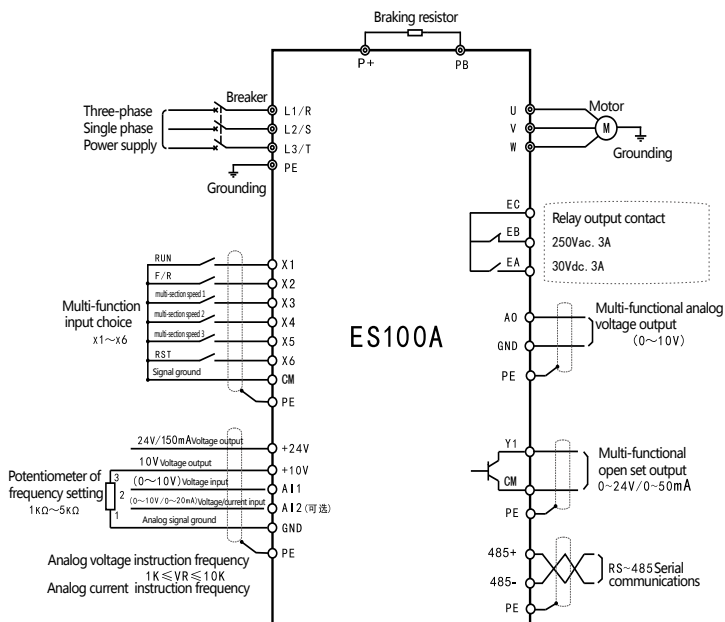

Fig 3-8 Wiring diagram of ES100A series inverter and peripheral devices;

3.2.2 Wiring diagram of main circuit terminals and control circuit terminals.

ES100A series inverter's standard wiring diagram of main circuit and control circuit is shown as fig 3-9:



- Warning:
- 1 indicates shielded wire connection.
 - 2 indicates main terminal, indicates control terminal.
 - 3 GND and CM are connected to common ground

Fig 3-9 Standard wiring diagram of main circuit and control circuit

- When multifunctional output terminals are connected to inductive load (e.g. relay coil), make sure to connect freewheel diodes to both ends of load in parallel.
- The distance from inverter or control wire in cabinet to power cable should be 100mm at least. Being in the same wiring trough is forbidden; if signal wire must go through power cable, both should maintain orthogonal position (90° angle). Control wire should be shielded twisted pair and shielded layer be connected to GND of terminal. Power cable should be sheathing and shielding cable for better.
- As strong electromagnetic interference is unavoidable to inverter, it will cause bad influence on various electric devices and instruments in the same environment. To restrain the interference, output cable of inverter can be fitted into a grounded metal pipe or sheathing and shielding cable should be used and grounded. Besides, addition of magnet ring to output cable can also effectively restrain the interference.

3.2.3 Function of main circuit terminal

Main circuit terminal of ES100A series inverter is shown as follow diagram:



ES100 0.4KW-15KW major loop terminals diagram



ES100 18KW-22KW major loop terminals diagram

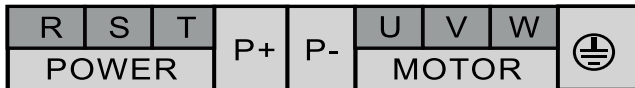

ES100 30KW-37KW major loop terminals diagram

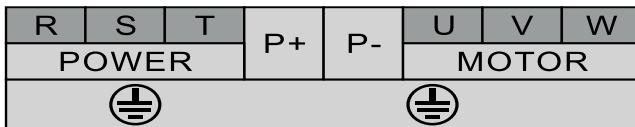

ES100 45KW-55KW major loop terminals diagram

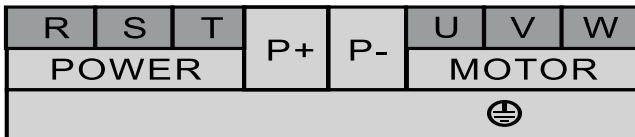

ES100 75KW-90KW major loop terminals diagram

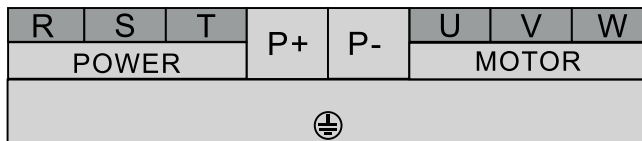

ES100 110KW major loop terminals diagram

R	S	T	P+	P-
POWER				
U	V	W	⊕	
MOTOR				

ES100 132KW–160KW major loop terminals diagram

Terminal Label	Function description
R、S、T	AC power supply input terminal .Three phase R/S/T or single phase linking to R/T.
U、V、W	Inverter output terminal ,linking to three–phase AC asynchronous motor.
P+、P-	Positive/Negative connection terminal of DC busbar.
PB	External braking resistor connecting terminal ,one end linking to P+ and the other linking to PB.
PE	Grounding to the earth .

- Must not connect any terminal beyond R/S/T to AC 380V power source, otherwise, there is risk of damage in inverter.
- Check if rated input voltage of inverter is consistent with the voltage of AC power supply. If not, there is risk of damage.
- Make sure to connect grounding terminal of inverter and motor housing to ground lead. Ground lead should be copper wire and sectional area should be above 4cm², and ground resistance must be lower than 10Ω.
- Must connect a non–fuse breaker between power supply and inverter lest the accident caused by inverter fault becomes serious, damages power distribution unit or results in a fire.

3.2.4 Wiring of main circuit

The diagram of main circuit wiring of ES100A series inverter is shown as fig 3–10:

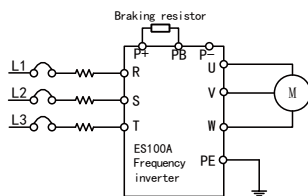

Fig 3–10 Standard wiring of main circuit

3.2.5 Input side wiring of main circuit

◆ Breaker installation

Make sure to install an appropriate air circuit breaker (MCCB) for inverter between power supply and input terminals.

MCCB capacity should be 1.5 ~ 2 times of rated current of inverter.

Time characteristic of MCCB should meet the requirement of that of overheat protection (150% of rated current /1min).

When MCCB is shared with multiple inverters or other devices, please connect inverter fault output relay contact to power contactor coil in series connection, as shown in Fig 3-11. Fault signal may cut off power supply.

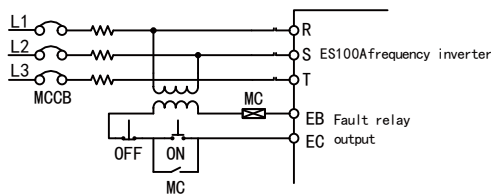

FIG. 3-11 Wiring Diagram of Main Circuit Breaker

◆ Leakage protection switch installation

As inverter output is high-frequency PWM signal, it will produce high-frequency leakage current. Please choose special leakage breaker for inverter of current sensitivity above 30mA; if a common leakage breaker should be chosen, please choose the model of current sensitivity above 200mA and action time above 0.1sec.

◆ Electromagnetic contactor installation

Connect an electromagnetic contactor which matches the power of inverter as shown in Fig 3-11. Do not frequently use incoming-line side electromagnetic contactor to control and stop inverter as this is an important cause to the damage of inverter. If it is a must to control with incoming-line side electromagnetic contactor, frequency of operation and stop should be no lower than 30 min/time. After recovery from power-cut, inverter will not automatically run.

◆ Installation of AC electric reactor

When capacitive load is present in input power supply, it will create very great surge current which may damage inverter. In this case, please connect a triple-phase/single phase AC reactor (optional) to input side of inverter. In this way, it can not only inhibit peak current and voltage, but also can improve power factor of system.

◆ Noise filter installation

To keep the noise from inverter and prevent the influence of the noise of inverter on power grid, a special noise filter is required for inverter. As the performance of common noise filter is not good, it is not applicable. Correct and wrong installation way of noise filter is shown in Fig 3-12 and 3-13.

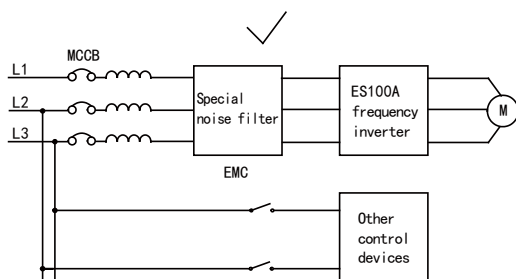

Fig 3-12 Diagram of correct installation wiring of noise filter

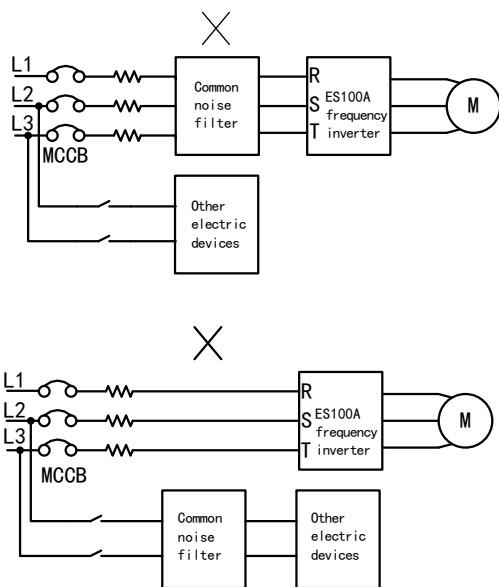

Fig 3-13 Diagram of incorrect wiring of noise filter

3.2.6 Output side wiring of main circuit

◆ Motor wiring and installation

Connect the output terminals U, V and W of inverter to input terminals of motor, U, V and W. Please confirm if motor makes forward rotation when forward rotation command is applied. To change rotation direction of motor, we just need to change any two wires of output terminal U, V and W.

◆ Must not connect power input to output terminals

Must not connect power wire to U, V and W terminal, after U, V and W terminal is imposed with voltage, components of inverter will be damaged.

◆ Must not short out output terminals or ground them

Must not directly touch terminals or short out output wire and inverter housing; otherwise, there would be risk of electric shock and short-circuit. Besides, must not short out output wires.

◆ Must not apply phase-shifting capacity

Must not connect a phase-shifting capacity or LC/RC filter to output circuit; otherwise, it would damage inverter.

◆ Must not apply electromagnetic switch

Must not connect an electromagnetic switch or electromagnetic contactor in output circuit; otherwise, when this type of components acts, overcurrent and overvoltage protection action would be activated. In a serious case, internal components of inverter would be damaged.

◆ Noise filter installation

The connection of noise filter to output side of inverter may reduce inductive interference and radio interference. Inductive interference: electromagnetic induction creates noise in signal line resulting in false action of control devices. Radio interference: inverter itself and high-frequency electromagnetic wave will disturb radio equipment nearby and produce noise during signal reception. Installation of noise filter on output side is shown in Fig 3-14.

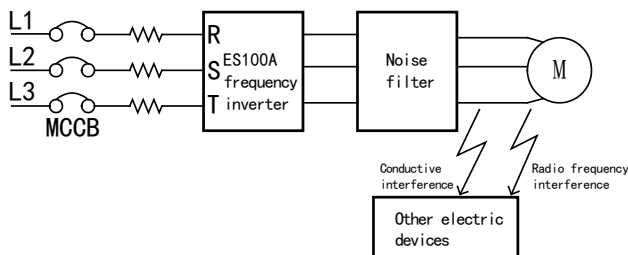

Fig 3-14 Diagram of noise filter's installation wiring of output side

◆ Anti-interference installation example

To inhibit the inductive interference of output side, besides installation of noise filter mentioned before, we can also put all output wires into grounded metal tube. When interval between output wire and signal wire is larger than 30cm, influence of inductive interference will be significantly reduced. Input wire, output wire and inverter itself will produce radio-frequency interference, installing noise filters on both output sides and screening inverter with iron box can also reduce radio-frequency interference. As shown in Fig 3-15, when multiple inverters work together, it is recommended to use the connection way in Fig 3-16.

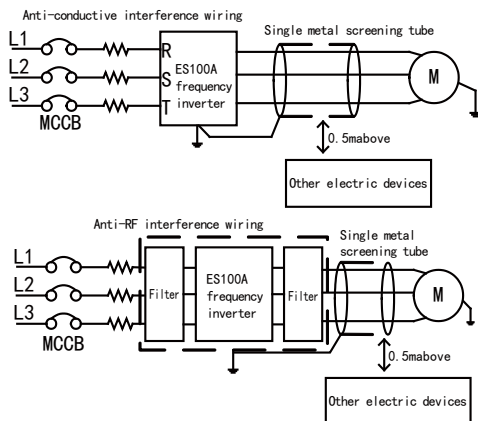

Fig 3-15 Anti-interference installation wiring

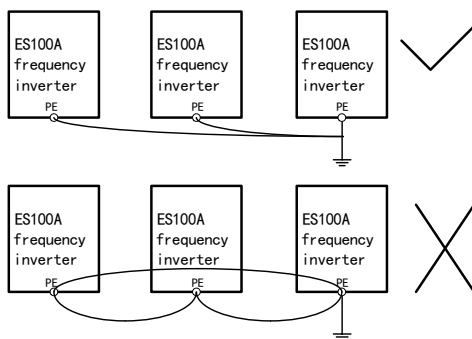

Fig 3-16 Recommended grounding method

3.2.7 Function of control circuit terminal

Method of control circuit terminal of ES100A series frequency inverter is shown as follow diagram:

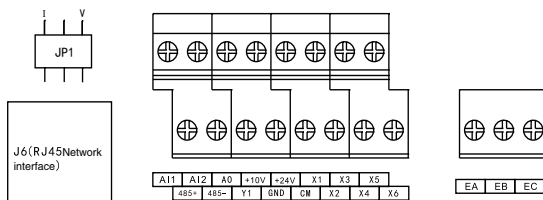
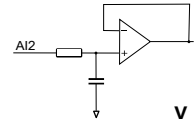
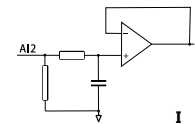
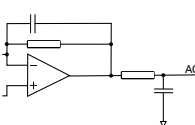

Fig 3-17 control circuit terminal

Type	Terminal Label	Function description	Electric specification	internal circuit
Digital multi-function terminal	X1	Such function as start, stop and forward/reverse rotation can be programmed by function code.	Input impedance 27K Ω ; Input voltage: 0~24V; Input frequency<1KHz; Valid for low level	
	X2			
	X3			
	X4			
	X5			
	X6			
Switching value terminal output	Y1	Function code programmes outward output to reflect such status as frequency inverter's forward/reverse rotation, frequency arrival .	Open set output; Capacity of load: 50mA/24V; Output frequency:<1KHz;	
	EA	Relay output can be programmed by function code .EA,EB and EC are respectively relay normally open, normally close and common terminal.	Contact capacity: 3A/250VAC Output frequency: <50Hz	
	EB			
	EC			
Analog input output terminal	AI1	AI1: Analog input output terminal	Voltage source: Input voltage: 0~10V; Input impedance: 1M Ω ;	

Analog input output terminal	AI2	AI2 can input voltage/ current (voltage input by default, can be set as current input by dial switch JP1),	Voltage source: Input voltage: 0~10V; Input impedance: 1M Ω ; Current source: (optional) Input current: 0~20mA; Input impedance: 250 Ω ; Resolution: 0.2%;	 <p style="text-align: right;">V</p> <p style="text-align: center;">Switching by JP1</p>  <p style="text-align: right;">I</p>
	AO	AO output can be programmed by function code to outward output and reflect the status of frequency inverter' s operation frequency and set frequency .	Output voltage: 0~10V; Capacity of load: <4mA; Resolution: 0.1V;	 <p style="text-align: right;">AO</p>

Chapter 4 Keypad Operation

4.1 Introduction

Nixie tube keypad of ES100A series current vectorial inverter is composed by 5-bit 8-segment nixie tube, 5 status indicator lamps, 8 keys and 1 rotational potentiometer. By the keypad, user can complete start, stop, status monitoring, fault inquiry, parameter modification, speed regulation and so on. Appearance of keypad is shown in Fig 4-1.

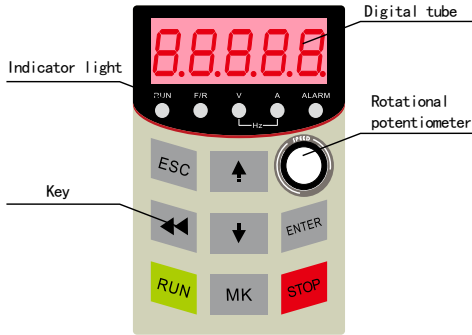



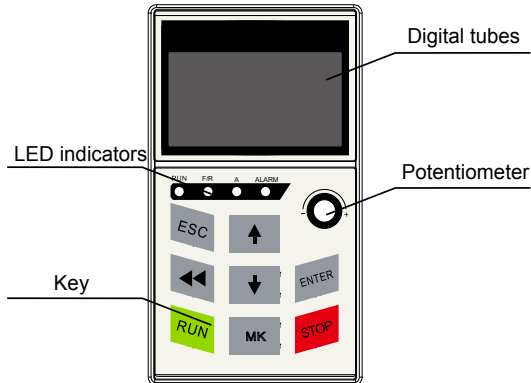







Small keypad fits 0.4KW to 15KW models



Big keypad fits 18.5KW to 160KW models

Picture 4 -1 Keyboard introduction

Keyboard functional description of each part

Picture	Name	Functional description
	5-bit 8-segment nixie tube	Display parameter code, parameter value, status monitoring and so on
	5 status indicator lamps	RUN: It means constant bright when operation and extinguish when stop. Blinking indicates deceleration. F/R: It means extinguish when forward rotation, constant bright when reverse rotation. A: Constantly bright indicates unit of current display data is ampere. V: Constantly bright indicates unit of current display data is volt. A/V: Both are constant bright indicating unit of current display is hertz. ALARM: Constantly bright indicates inverter is in fault alarming status.
	1 potentiometer	Change the feeding of frequency source to embody frequency inverter's speed governing.
	ESC key	Back to the previous status or cancel current parameter modification.
	UP key	Increase parameter code, parameter value or parameter group.
	Shift key	Switching of operation status monitoring data and switching of parameter bit.
	Down key	Decrease of parameter code, parameter value or parameter group.
	Enter key	Enter parameter menu and ensure current modification value.
	RUN key	Command key of keypad operation.
	MK key	Multi-functional key can be set as invalid, inching or forward/reverse rotation function.
	STOP key	Command key of keypad stop or fault reset.

4.2 Keypad Display

ES100A series compact vectorial frequency inverter's all status are shown as follow.

Stop status: given frequency 30.95Hz.

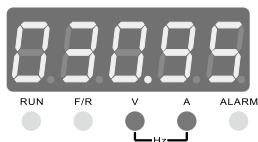

Operation status: running in forward rotation, frequency 30.95Hz.

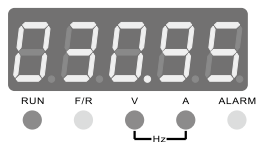

Parameter edition status: secondary menu.



Abnormal status: fault code 10.



4.3. Keypad Operation

The keypad of ES100A series compact vectorial frequency inverter embodies parameter setting, status monitoring and other operations by 3-level menus, including parameter group (level 1 menu), function code (level 2 menu) and parameter value (level 3 menu).

4.3.1 Parameter setting

To perform ES100A series compact vectorial frequency inverter parameter setting, we can carry out parameter group switching, function code switching and parameter value modification.

parameter group switching

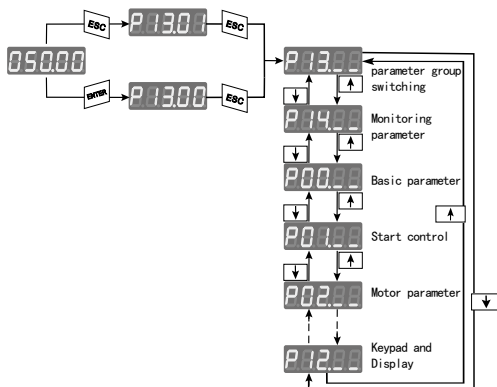

function code switching

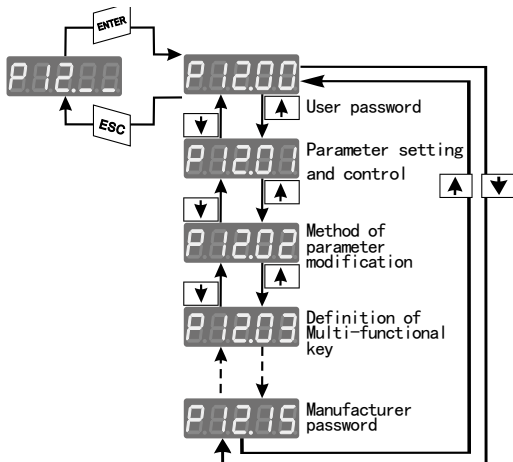

parameter value modification

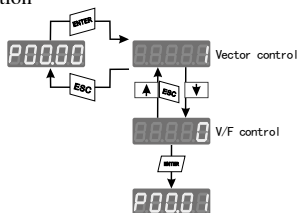

In level 3 menu, if a parameter has no blinking digit, it indicates current function code cannot be modified. Possible reasons include:

- ◆ Current function code is read-only;
- ◆ Current function code is non-modifiable in running status and becomes modifiable after stop;

4.3.2 Status monitoring

When inverter is in running status, press  key to have Nixie tube display current output frequency (before compensation) (P13.01), output voltage (P13.03), output current (P13.04), busbar voltage (P,13.07) and input frequency(13.00)in cycle.

When inverter is in running or stop status, user can monitor the work status of inverter through monitoring parameter (P13.XX), such as input frequency, output frequency, output voltage, radiator temperature and so on.

4.3.3 Potentiometer operation

When keypad potentiometer is selected as frequency source of inverter, output frequency can be adjusted by keypad potentiometer.

4.3.4 Start/stop control

If command source is selected as current keypad, namely P00.01=0, inverter output can be controlled by RUN and STOP key.

4.3.5 MK multifunctional programming key

If P12.03=1, user can have inverter run by set jog frequency by **[MK]** key.

If P12.03=2, user can control inverter output by **[MK]** key to embody forward/reverse rotation switching of output frequency.

4.3.6 Fault reset/inquiry

When inverter meets fault, press STOP key to quit fault status; otherwise, the inverter will remain current fault status.

Chapter 5 Function Parameter Table

“○” : A code parameter is modifiable when inverter is in running status.

“◉” : A code parameter is non-modifiable when inverter is in running status.

“×” : A code parameter is read-only and non-modifiable.

P00 group :Basic parameter

Function code	Name	Set range	Unit	Factory Default	Property
P00.00	Control Way	0: Open loop vector 1: SVC vector		0	◉
P00.01	Command source choice	0: Locate keypad 1: External terminal 2: Computer communication		0	◉
P00.02	Main frequency source choice	0: Main digital frequency 1: Keypad potentiometer 2: AI1 3: AI2		1	◉
P00.03	Auxiliary frequency source choice	0: Auxiliary digital frequency 1: Keypad potentiometer 2: AI1 3: AI2 4: PLC 5: PID		0	◉
P00.04	Output frequency source choice	0: Main frequency source 1: Auxiliary frequency source 2: main+auxiliary 3: main -auxiliary 4: MAX (main ,auxiliary) 5: MIN (main ,auxiliary)		0	◉
P00.05	Auxiliary frequency source range in staking	0:Relative to maximum frequency 1:Relative to main frequency		0	◉
P00.06	Auxiliary frequency source proportion in staking	0.00 ~ 200.00	%	100.00	○
P00.07	Output frequency source control	0: output frequency source 1: AI1*Output frequency source 2: AI2*Output frequency source		0	◉
P00.08	Main digital frequency	0.00 ~ Maximum frequency	Hz	0.00	○

P00.09	Auxiliary digit frequency	0.00 ~ Maximum frequency	Hz	0.00	○
P00.10	Rotation direction setting	0: Forward 1: Reverse		0	○
P00.11	Accelerate time1	0.00 ~ 600.00	S	20.00	○
P00.12	Decelerate time1	0.00 ~ 600.00	S	20.00	○
P00.13	Carrier frequency	2.000 ~ 10.000	KHz	4.000	○
P00.14	Maximum frequency	20.00 ~ 600.00	Hz	50.00	◎
P00.15	Upper limit frequency	Lower limit frequency ~ Maximum frequency	Hz	50.00	◎
P00.16	Lower limit frequency	0.00 ~ Upper limit frequency	Hz	0.00	◎
P00.17	Lower limit frequency control	0: Operation at lower limit frequency 1: Run at 0 speed after lower limit frequency times up		0	◎
P00.18	Lower limit frequency operation time	0.00 ~ 600.00	S	60.00	◎
P00.19	Reverse rotation control	0: clockwise rotation/counter-clockwise rotation are permitted 1: counter-clockwise is prohibited		0	◎
P00.20	Forward/Reverse rotation dead time	0.00 ~ 600.00	S	0.00	◎
P00.21	Load velocity coefficient	0.01 ~ 300.00		30.00	○
P00.22	Reset to Factory default	0: Invalid 1: Reset to Factory default		0	◎

P01 group: Start/stop control

Function code	Name	Set range	Unit	Factory Default	Property
P01.00	Accelerate/Decelerate mode	0: Linear mode 1: S curve mode		0	◎
P01.01	Start way	0: Direct start 1: Start rotational speed tracking		0	◎
P01.02	Start DC braking current	0.00 ~ 150.00	%	0.00	◎

P01.03	Start DC braking time	0.00 ~ 30.00	S	0.00	○
P01.04	Stop way	0: Stop in decelerate 1: Free stop		0	○
P01.05	Stop DC braking frequency	0.10 ~ Upper limit frequency	Hz	2.00	○
P01.06	Stop DC braking current	0.00 ~ 150.00	%	0.00	○
P01.07	DC braking waiting time	0.01 ~ 30.00	S	0.50	○
P01.08	Stop DC braking time	0.00 ~ 30.00	S	0.00	○
P01.09	Tracking initiation frequency	0: Maximum frequency 1: Stop frequency		1	○
P01.10~ P01.21	Reserve				
P01.22	terminal start up reconfirm	0: needless 1: needed		0	○

5

P02 group : Motor 1 parameter

Function code	Name	Set range	Unit	Factory Default	Property
P02.00	Motor rated power	0.10 ~ 600.00	KW	XX.XX	○
P02.01	Motor rated voltage	50 ~ 660	V	XXX	○
P02.02	Motor rated current	0.01 ~ 600.00	A	XX.X	○
P02.03	Motor rated frequency	20.00 ~ 600.00	Hz	XX.XX	○
P02.04	Motor rated speed	1 ~ 60000	rpm	XXXX	○
P02.05	Method of motor connection	0: Y 1: Δ		X	○
P02.06	Power factor	0.600 ~ 1.000		X.XX	○
P02.07	Motor efficiency	30.0 ~ 100.0	%	XX.XX	○
P02.08	No-load current	0.01 ~ 600.00	A	XX.X	○
P02.09	Stator resistance	1 ~ 60000	mΩ	XX.X	○
P02.10	Rotor resistance	1 ~ 60000	mΩ	XX.X	○
P02.11	Mutual inductance of asynchronous motor	0.1 ~ 6000.0	mH	XXX.X	○
P02.12	Leakage inductance of asynchronous motor	0.01 ~ 600.00	mH	X.XXX	○

P02.13	Auto-identification of parameter	0: no identification 1: self-identification at stop 2: self-identification in rotation		0	⊙
P02.14	Flux-weakening coefficient 1	10.00 ~ 100.00	%	87	⊙
P02.15	Flux-weakening coefficient 2	10.00 ~ 100.00	%	80	⊙
P02.16	Flux-weakening coefficient 3	10.00 ~ 100.00	%	75	⊙
P02.17	Flux-weakening coefficient 4	10.00 ~ 100.00	%	72	⊙
P02.18	Flux-weakening coefficient 5	10.00 ~ 100.00	%	70	⊙

P03 group :V/F parameter

Function code	Name	Set range	Unit	Factory Default	Property
P03.00	V/F curve setting	0: Straight line V/F curve 1: Multi-point V/F curve 2: Fan curve 1 3: Fan curve 2 4: Fan curve 3 5: Fan curve 4 6: VF completed separation mode		1	⊙
P03.01	Reservation				
P03.02	V/F voltage value V0	0.00 ~ 100.00	%	1.00	○
P03.03	V/F voltage value V1	0.00 ~ 100.00	%	4.00	○
P03.04	V/F voltage value V2	0.00 ~ 100.00	%	10.00	○
P03.05	V/F voltage value V3	0.00 ~ 100.00	%	16.00	○
P03.06	V/F frequency value F0	0.00 ~ frequency value F1	%	1.00	○
P03.07	V/F frequency value F1	frequency value F0 ~ frequency value F2	%	4.00	○
P03.08	V/F frequency value F2	frequency value F1 ~ frequency value F3	%	10.00	○
P03.09	V/F frequency value F3	frequency value F2 ~ 100.00	%	16.00	○
P03.10	Voltage source of VF separation	0: Digital setting of VF separated voltage 1: Keypad potentiometer 2: AI1 3: AI2 4: PID		0	⊙

P03.11	Voltage setting of VF separation digital	0.0 ~ 100.0	%	0.0	○
P03.12	Rise-time of VF separation voltage	0.00 ~ 60.00	S	5.00	○

P04 group: Input terminal control

Function code	Name	Set range	Unit	Factory Default	Property												
P04.00	DI terminal wave filtering	0 ~ 100		10	◎												
P04.01	DI input logic	<table border="1"> <tr> <td>Bit5</td><td>Bit4</td><td>Bit3</td><td>Bit2</td><td>Bit1</td><td>Bit0</td> </tr> <tr> <td>X6</td><td>X5</td><td>X4</td><td>X3</td><td>X2</td><td>X1</td> </tr> </table> 0: Close valid 1: Break valid	Bit5	Bit4	Bit3	Bit2	Bit1	Bit0	X6	X5	X4	X3	X2	X1		000000	◎
Bit5	Bit4	Bit3	Bit2	Bit1	Bit0												
X6	X5	X4	X3	X2	X1												
P04.02	X1 valid delay time	0.000 ~ 30.000	S	0.000	○												
P04.03	X2 valid delay time	0.000 ~ 30.000	S	0.000	○												
P04.04	Multi-functional input X1	0: no function 1: run RUN 2: forward/reverse rotation F/R 3: 3-thread operation stop control 4: forward rotation jog FJOG 5: reverse rotation jog RJOG 6: terminal UP 7: terminal DOWN 8: UP / DOWN reset		1	◎												
P04.05	Multi-functional input X2	9: free stop FRS 10: fault reset RST 11: external fault EXT 12: Accelerate/ Decelerate forbidden		2	◎												
P04.06	Multi-functional input X3	13: multi-segment frequency terminal 1		13	◎												
P04.07	Multi-functional input X4	14: multi-segment frequency terminal 2		14	◎												
P04.08	Multi-functional input X5	15: multi-segment frequency terminal 3		15	◎												
P04.09	Multi-functional input X6	16: Accelerate/decelerate time switching 17: Operation command switching to terminal 18: Switching to auxiliary speed 19: Stop DC braking 20: Program operation reset 21: Multi-segment torque terminal1 22: Multi-segment torque terminal2 23: PID parameter switching		10	◎												
P04.10	Terminal command way	0: 1-thread control 1: 2-thread control 2: 1-thread control 3: 2-thread control		0	◎												
P04.11	analog input curve option	Ones place: All curve option 0: curve 1(two point) 1: curve 2(two point)		120D	◎												

P04.11	analog input curve option	2: curve 3(four point) 3: curve 4(four point) Tens place: AI2 curve option 0: curve 1(two point) 1: curve 2(two point) 2: curve 3(four point) 3: curve 4(four point) hundreds place: VP curve option 0: curve 1(two point) 1: curve 2(two point) 2: curve 3(four point) 3: curve 4(four point)		120D	◎
P04.12	Curve 1 minimum input	0.00 ~ P04.14	V	0.1	○
P04.13	Curve 1 minimum input corresponding given	-100.0 ~ +100.0	%	0	○
P04.14	Curve 1 maximum input	P04.12 ~ 10.00	V	9.9	○
P04.15	Curve 1 maximum input corresponding given	-100.0 ~ +100.0	%	100	○
P04.16	Curve 2 minimum input	0.00 ~ P04.18	V	0.1	○
P04.17	Curve 2 minimum input corresponding given	-100.0 ~ +100.0	%	0	○
P04.18	Curve 2 maximum input	P04.16 ~ 10.00	V	9.9	○
P04.19	Curve 2 maximum input corresponding given	-100.0 ~ +100.0	%	100	○
P04.20	Curve 3 minimum input	0.00 ~ P04.22	V	0.1	○
P04.21	Curve 3 minimum input corresponding given	-100.0 ~ +100.0	%	0	○
P04.22	Curve 3 inflection 1 input	P04.20 ~ P04.24	V	2.5	○
P04.23	Curve 3 inflection 1 input corresponding given	-100.0 ~ +100.0	%	25	○
P04.24	Curve 3 inflection 2 input	P04.22 ~ P04.26	V	7.5	○
P04.25	Curve 3 inflection 2 input corresponding given	-100.0 ~ +100.0	%	75	○
P04.26	Curve 3 maximum input	P04.24 ~ 10.00	V	9.9	○
P04.27	Curve 3 maximum input corresponding given	-100.0 ~ +100.0	%	100	○
P04.28	Curve 4 minimum input	0.00 ~ P04.30	V	0.1	○
P04.29	Curve 4 minimum input corresponding given	-100.0 ~ +100.0	%	0	○
P04.30	Curve 4 inflection 1 input	P04.28 ~ P04.32	V	2.5	○
P04.31	Curve 4 inflection 1 input corresponding given	-100.0 ~ +100.0	%	25	○

P04.32	Curve 4 inflection 2 input	P04.30 ~ P04.34	V	7.5	○
P04.33	Curve 4 inflection 2 input corresponding given	-100.0 ~ +100.0	%	75	○
P04.34	Curve 4 maximum input	P04.32 ~ 10.00	V	9.9	○
P04.35	Curve 4 maximum input corresponding given	-100.0 ~ +100.0	%	100	○
P04.36	A11 proportional gain	0.00 ~ 300.00	%	100	○
P04.37	A12 proportional gain	0.00 ~ 300.00	%	100	○
P04.38	A11 filtering time	0.00 ~ 10.00	s	0.1	○
P04.39	A12 filtering time	0.00 ~ 10.00	s	0.1	○
P04.40	VP filtering time	0.00 ~ 10.00	s	0.1	○
P04.41	AD Sampling Hysteresis	0 ~ 200		10	◎
P04.42	X1 Invalid delay time	0.000 ~ 30.000	s	0	○
P04.43	X2 Invalid delay time	0.000 ~ 30.000	s	0	○
P04.44	X3 Valid delay time	0.000 ~ 30.000	s	0	○
P04.45	X3 Invalid delay time	0.000 ~ 30.000	s	0	○
P04.46	X4 Valid delay time	0.000 ~ 30.000	s	0	○
P04.47	X4 Invalid delay time	0.000 ~ 30.000	s	0	○
P04.48	X5 Valid delay time	0.000 ~ 30.000	s	0	○
P04.49	X5 Invalid delay time	0.000 ~ 30.000	s	0	○
P04.50	X6 Valid delay time	0.000 ~ 30.000	s	0	○
P04.51	X6 Invalid delay time	0.000 ~ 30.000	s	0	○

5

P05 group: Output terminal function

Function code	Name	Set range	Unit	Factory Default	Property
P05.00	Multi-functional output Y1	0: Frequency inverter running 1: Reverse rotation running 2: Frequency arrival (FAR) 3: Frequency level detection (FDT) 4: Frequency inverter fault 5: Upper frequency arrival 6: Lower frequency arrival 7: Ready for running 8: Frequency level detection (FDT) , invalid for JOG 9: overload pre-alarm		0	◎
P05.01	Relay output R1			4	◎
P05.02	Analog output AO	0: Operation frequency 1: Set frequency 2: output current 3: Output voltage 4: Busbar voltage 5: A11 6: A12 7: +10V 8: Reservation		0	◎

P05.03	AO Output lower limit	0.00 ~ 100.00	%	0.00	○
P05.04	AO Output upper limit	0.00 ~ 100.00	%	100.00	○
P05.05	AOoutput enhancement	0.00 ~ 300.00	%	100.00	○
P05.06	FDT upper bound	0.00 ~ Maximum frequency	Hz	30.00	◎
P05.07	FDT lower bound	0.00 ~ Maximum frequency	Hz	30.00	◎
P05.08	FAR frequency arrival	0.00 ~ 20.00	Hz	2.50	◎

P06 group: Auxiliary function

Function code	Name	Set range	Unit	Factory Default	Property
P06.00	Jog digital frequency	0.00 ~ Maximum frequency	Hz	5.00	○
P06.01	Inching accelerate time	0.00 ~ 600.00	S	20.00	○
P06.02	Inching decelerate time	0.00 ~ 600.00	S	20.00	○
P06.03	Accelerate time 2	0.00 ~ 600.00	S	20.00	○
P06.04	Decelerate time 2	0.00 ~ 600.00	S	20.00	○
P06.05	Multi-segment speed 1	0.00 ~ Maximum frequency	Hz	0.00	○
P06.06	Multi-segment speed 2	0.00 ~ Maximum frequency	Hz	5.00	○
P06.07	Multi-segment speed 3	0.00 ~ Maximum frequency	Hz	10.00	○
P06.08	Multi-segment speed 4	0.00 ~ Maximum frequency	Hz	15.00	○
P06.09	Multi-segment speed 5	0.00 ~ Maximum frequency	Hz	20.00	○
P06.10	Multi-segment speed 6	0.00 ~ Maximum frequency	Hz	25.00	○
P06.11	Multi-segment speed 7	0.00 ~ Maximum frequency	Hz	30.00	○
P06.12	UP/DOWN velocity	0.00 ~ 100.00 0.00 (Automatic rate)		1.00	○
P06.13	Power down storage	0: Non storage the frequency before power down 1:Storage the frequency before power down 2:UP/DOWN stop reset		0	◎
P06.14	Monitoring parameter of keypad second line	0 ~ 20 (P13.00 ~ P13.18)		4	○

P07 group: communication function

Function code	Name	Set range	Unit	Factory Default	Property
P07.00	Local address	0: Broadcasting address 1 ~ 247		1	◎
P07.01	Communication Baud rate	0: 4800 1: 9600 2: 19200 3: 38400	bps	1	◎

P07.02	Communication format	0: no parity 1+8+1 1: even parity check 1+8+1+1 2: odd parity check 1+8+1+1		0	⊙
P07.03	Communication overtime time	0.0 ~ 60.0 0.0 Function invalid when communication overtime	S	0.0	⊙
P07.04	Master-slave communication way	0:Current machine is slave 1:Current machine is master		0	⊙
P07.05	Master write slave address	0: Main digital frequency 1: Auxiliary digital frequency		0	⊙
P07.06	Received proportion coefficient of local machine	0.00 ~ 300.00	%	100.00	○
P07.07	Master communication sending data	0: Output frequency 1: Set frequency 2: Main digital frequency 3: Keypad potentiometer 4: AI1 5: AI2		0	⊙

5

P08:PID control function

Function code	Name	Set range	Unit	Factory Default	Property
P08.00	PID given source	0: Digital given 1: AI1 2: AI2		0	⊙
P08.01	PID digital given	0.0 ~ P08.03PID maximum scale	%	50.0	○
P08.02	PID feedback source	0: AI1 1: AI2		0	⊙
P08.03	PID maximum scale	0.1 ~ 6000.0		100.0	○
P08.04	PID effect direction	0: Positive effect 1: Negative effect		0	⊙
P08.05	PID output gain	0.00 ~ 100.00	%	100.00	○
P08.06	Proportion gain Kp	0.00 ~ 100.00		0.40	○
P08.07	Integral time Ti	0.000 ~ 30.000, 0.000:no integral	S	2.000	○
P08.08	Differential time Td	0.000 ~ 30.000, 0.000:no differential	mS	0.000	○
P08.09	Integral effect range	0.00 ~ 100.00	%	100.00	○
P08.10	PID deviation limit	0.00 ~ 100.00	%	0.00	○
P08.11	PID output upper limit	PID output lower limit ~ 100.0	%	100.0	○
P08.12	PID output lower limit	-100.0 ~ PID Output upper limit	%	0.0	○

P08.13	PID feedback disconnection detection value	0.00 ~ 100.00	%	0.0	○
P08.14	PID feedback disconnection detection time	0.0 ~ 30.0	S	1.0	○
P08.15	Start threshold	0.00 ~ Sleep threshold	%	0.0	○
P08.16	Start delay time	0.0 ~ 30.0	S	0.0	○
P08.17	Sleep threshold	Start the threshold ~ 100.00	%	100.00	○
P08.18	Sleep delay time	0.0 ~ 30.0	S	0.0	○
P08.19	PID given variation time	0.000 ~ 30.000	S	0.000	○
P08.20	PID feedback filtering time	0.000 ~ 30.000	S	0.000	○
P08.21	PID output filtering time	0.000 ~ 30.000	S	0.000	○
P08.22	Proportion gain 2	0.00 ~ 100.00		0.40	○
P08.23	Integral time 2	0.000 ~ 30.000, 0.000: no integral	S	10.000	○
P08.24	Differential time 2	0.000 ~ 30.000	MS	0.000	○
P08.25	PID parameter switching condition	0: No switch 1: Switching through digital input terminals 2: Automatic switching according to deviation		0	○
P08.26	PID parameter switching deviation 1	0.00 ~ P08.27	%	20.00	○
P08.27	PID parameter switching deviation2	P08.26 ~ 100.00	%	80.00	○
P08.28	PID initial value	0.00 ~ 100.00	%	0.00	○
P08.29	PID initial storage time	0.00 ~ 650.00	S	0.00	○

P09 group :simple PLC function

Function code	Name	Set range	Unit	Factory Default	Property
P09.00	PLC operation way	0: Shut down after a single run 1: Shut down after a finite cycle is completed 2: After a single run, run in paragraph 7 3: Cycle run		0	◎

P09.01	PLC operation control	0: Run from the interrupt period 1: Start with the first section		0	⊙														
P09.02	PLC operation direction	<table border="1"> <tr> <td>Bit6</td><td>Bit5</td><td>Bit4</td><td>Bit3</td><td>Bit2</td><td>Bit1</td><td>Bit0</td> </tr> <tr> <td>T7</td><td>T6</td><td>T5</td><td>T4</td><td>T3</td><td>T2</td><td>T1</td> </tr> </table> 0: Forward rotation 1: Reverse rotation	Bit6	Bit5	Bit4	Bit3	Bit2	Bit1	Bit0	T7	T6	T5	T4	T3	T2	T1		0000000	⊙
Bit6	Bit5	Bit4	Bit3	Bit2	Bit1	Bit0													
T7	T6	T5	T4	T3	T2	T1													
P09.03	Section 1 operation time T1	0 ~ 60000	S	30	○														
P09.04	Section 2 operation time T2	0 ~ 60000	S	30	○														
P09.05	Section 3 operation time T3	0 ~ 60000	S	30	○														
P09.06	Section 4 operation time T4	0 ~ 60000	S	30	○														
P09.07	Section 5 operation time T5	0 ~ 60000	S	30	○														
P09.08	Section 6 operation time T6	0 ~ 60000	S	30	○														
P09.09	Section 7 operation time T7	0 ~ 60000	S	30	○														
P09.10	Limited cycle times	1 ~ 30000		1	○														

P10 group :Fault and protection

Function code	Name	Set range	Unit	Factory Default	Property
P10.00	Motor overload protection	0: invalid 1: effective		0	⊙
P10.01	Reservation				
P10.02	Overcurrent stall protection	0: Invalid 1: Mode 1 2: Mode 2		2	⊙
P10.03	Current limiting level	50.0 ~ 180.0	%	150.0	⊙
P10.04	Over-voltage stall protection	0: Invalid 1: Valid for over-voltage stall		1	⊙
P10.05	Stall over-voltage point	380V: 640 ~ 800 220V: 370 ~ 400	V	720	⊙
				390	
P10.06	Fault retry control	0: Fault retry invalid 1-3: Fault retry 1,2,3times 4: Infinite fault retry		0	⊙

P10.07	Fault output option during Fault retry	0: no action 1: action		0	⊙																
P10.08	Fault retry internal	0.01 ~ 30.00	S	0.50	⊙																
P10.09	No fault internal	0.01 ~ 30.00	S	10.00	⊙																
P10.10	Fault retry option	<table border="1"> <tr> <td>Bit4</td><td>Bit3</td><td>Bit2</td><td>Bit1</td><td>Bit0</td> </tr> <tr> <td>ER07</td><td>ER05</td><td>ER04</td><td>ER03</td><td>ER02</td> </tr> </table> 0: Invalid for fault retry 1: Valid for fault retry	Bit4	Bit3	Bit2	Bit1	Bit0	ER07	ER05	ER04	ER03	ER02		00000	⊙						
Bit4	Bit3	Bit2	Bit1	Bit0																	
ER07	ER05	ER04	ER03	ER02																	
P10.11	Fault screening	<table border="1"> <tr> <td>Bit7</td><td>Bit6</td><td>Bit5</td><td>Bit4</td> </tr> <tr> <td>*</td><td>ERR15</td><td>ERR12</td><td>ERR07</td> </tr> </table> <table border="1"> <tr> <td>Bit3</td><td>Bit2</td><td>Bit1</td><td>Bit0</td> </tr> <tr> <td>ERR10</td><td>ERR06</td><td>ERR05</td><td>ERR04</td> </tr> </table> 0: Protection is invalid 1: Protection is valid	Bit7	Bit6	Bit5	Bit4	*	ERR15	ERR12	ERR07	Bit3	Bit2	Bit1	Bit0	ERR10	ERR06	ERR05	ERR04		1111 1111	⊙
Bit7	Bit6	Bit5	Bit4																		
*	ERR15	ERR12	ERR07																		
Bit3	Bit2	Bit1	Bit0																		
ERR10	ERR06	ERR05	ERR04																		
P10.12	Overload pre-alarm option	0: Y terminal continues to output and keep running 1: Fault alarmed and stop (ERR07)		0	⊙																
P10.13	Overload pre-alarm detection level	20.00 ~ 200.00	%	130.00	⊙																
P10.14	Overload pre-alarm detection time	0.0 ~ 60.0	S	5.0	⊙																
P10.15	Power compensation coefficient	0.00 ~ 300.00	%	110	⊙																

P11group :Control parameter

Function code	Name	Set range	Unit	Factory Default	Property
P11.00	Fan control	0: Operation in power on 1: Start operation		1	⊙
P11.01	Carrier way	0: Fixed carrier 1: Random carrier		0	⊙
P11.02	Carrier upper limit	P11.03 ~ 10.00	KHz	6.000	○
P11.03	Carrier lower limit	2.000 ~ P11.02	KHz	2.000	○
P11.04	Automatic stabilivolt AVR	0: Invalid 1: Valid		1	⊙
P11.05	Energy consumption braking control	0: Invalid 1: Valid		1	⊙
P11.06	Braking usage rate	5.00 ~ 100.00	%	100.00	⊙
P11.07	Energy braking voltage	380V: 640 ~ 800 220V: 350 ~ 400	V	690 380	⊙
P11.08	Reservation				

P11.09	Over modulation function	0: Invalid 1: Valid		0	⊙
P11.10	Concussion inhibition gain	0 ~ 100		5	○
P11.11	V/F deviation compensation gain	0.00 ~ 200.00	%	100.00	○
P11.12	V/F stator voltage drop compensation gain	0.00 ~ 200.00	%	100.00	○
P11.13	Dead zone compensation	0: Invalid 1: Valid		1	⊙
P11.14	Flux braking gain	100 ~ 150 (100:no flux braking)		100	⊙
P11.15	Reservation				
P11.16	V/F deviation gain filtering time	0.00 ~ 10.00	S	1.00	⊙
P11.17	Concussion inhibition cut-off frequency	0.00 ~ 600.00	Hz	55.00	⊙
P11.18	terminal inching priority	0 : invalid 1 : valid		0	○

5

P12 group :Keypad and display

Function code	Name	Set range	Unit	Factory Default	Property
P12.00	User password	0 ~ 65535		XXXXXX	⊙
P12.01	Parameter setting control	0: Parameter setting allowed 1: Parameter locking 0 2: Parameter locking 1		0	⊙
P12.02	Parameter modification method	0: Keypad and communication are valid at the same time 1: Keypad is valid 2: Communication is valid		0	⊙
P12.03	Definition of multi-function key	0: Invalid 1: Inching operation 2: Switching between forward/reverse rotation		1	⊙
P12.04	Code selected of stop monitoring	0 ~ 17; P13.00 ~ P13.17		0	⊙
P12.05	Monitoring code selection	0 ~ 17; P13.00 ~ P13.17		1	⊙

P12.06	Frequency inverter operation time	0 ~ 65535	HOUR	XXXXXX	×
P12.07	Frequency inverter operation time	0 ~ 59	Min	XX	×
P12.08	Operation time control	0: Invalid 1: Valid		0	⊙
P12.09	Set operation time	0 ~ 65535	HOUR	XXXXXX	⊙
P12.10	Operation time controls password	0 ~ 65535		XXXXXX	⊙
P12.11	Frequency inverter rate power		kW	XXXX	×
P12.12	Frequency inverter rate voltage		V	XXX	×
P12.13	Frequency inverter rate current		A	XXXXX	×
P12.14	Software version			X.XX	×
P12.15	Manufacturer password	0 ~ 65535		XXXXXX	⊙

P13 group: Monitoring parameter

Function code	Name	Set range	Unit	Factory Default	Property
P13.00	Input frequency	0.00 ~ maximum frequency	Hz		×
P13.01	Output frequency (before compensation)	0.00 ~ Upper limit frequency	Hz		×
P13.02	Output frequency (after compensation)	0.00 ~ Upper limit frequency	Hz		×
P13.03	Output voltage	0.0 ~ 690.0	V		×
P13.04	Output current	0.00 ~ 300.00	A		×
P13.05	Load speed	0 ~ 30000	Rpm		×
P13.06	Output power	0.00 ~ 50.00	kW		×
P13.07	Busbar voltage	0 ~ 1200	V		×
P13.08	Radiator temperature	0 ~ 200	℃		
P13.09	PID given	0 ~ Maximum scale			×
P13.10	PID feedback	0 ~ Maximum range			×
P13.11	Program operation segment	1 ~ 7			×
P13.12	Program operation time	0 ~ 60000	S		×
P13.13	DI terminal status	** X6 X5 X4 X3 X2 X1			×
P13.14	DO terminal status	** ** ** ** R1 Y1			×

P13.15	Keyboard potentiometers	0.00 ~ 100.00	%		×
P13.16	AI1	0.00 ~ 100.00	%		×
P13.17	AI2	0.00 ~ 100.00	%		×
P13.18	PLC operation times				×
P13.19	Torque given	-200.0 ~ 200.0	%		×
P13.20	Output torque	-200.0 ~ 200.0	%		×

P14 group :Fault parameter

Function code	Name	Set range	Unit	Factory Default	Property
P14.00	Current first time fault record	ERR00: no fault ERR01: inverter unit fault ERR02: over-current fault ERR03: over-voltage fault ERR04: under-voltage fault ERR05: Input phase loss fault ERR06: output phase loss fault		00	×
P14.01	Current second time fault record	ERR07: frequency inverter overload ERR08: motor overload ERR09: overheat fault ERR10: PTC disconnection fault ERR11: soft start fault ERR12: external fault		00	×
P14.02	Current third time fault record	ERR13: communication overtime fault ERR14: PID feedback disconnection fault ERR15: memory fault ERR16: Cancel motor tune ERR17: abnormal fault of stator and resistance ERR18: no-load current fault ERR19: Timed locking machine		00	×
P14.03	Output frequency of current first time fault	0.00 ~ 600.00	Hz	0.00	×
P14.04	Output current of current first time fault	0.00 ~ 300.00	A	0.0	×
P14.05	Busbar voltage of current first time fault	0 ~ 1200	V	0	×

P15 group: torque control

Function code	Name	Set range	Unit	Factory Default	Property
P15.00	Speed/torque control option	0: velocity control 1: torque control		0	⊙
P15.01	Torque given source option	0: digital torque given P15.02 1: AI1 2: AI2 (full scale ,relative to P15.02 digital torque given)		0	⊙
P15.02	Digital torque given	-200.0 ~ 200.0 (100.0=motor rated torque)	%	100.0	○
P15.03	Accelerate/Decelerate time of torque control	0.00 ~ 120.00	S	0.05	○
P15.04	Upper limit frequency option of torque control	0: Set by P15.05 1: AI1 2: AI2		0	⊙
P15.05	Upper limit of torque control	0.00 ~ maximum frequency P00.14	Hz	50.00	○
P15.06	Upper frequency bias	0.00 ~ maximum frequency P00.14	Hz	0.00	○
P15.07	Static friction torque compensation	0.0 ~ 100.0	%	0.0	○
P15.08	Static friction compensation frequency range	0.00 ~ 50.00	Hz	1.00	○
P15.09	Dynamic friction torque compensation	0.0 ~ 100.0	%	0.0	○
P15.10	Multi-segment torque 1	-200.0 ~ 200.0	%	0.0	○
P15.11	Multi-segment torque 2	-200.0 ~ 200.0	%	0.0	○
P15.12	Multi-segment torque 3	-200.0 ~ 200.0	%	0.0	○
P15.13	Limit option of reverse velocity	0 ~ 100	%	100	×
P15.14	Preferential enabling of torque control velocity	0: no enable 1: enable		0	×

Chapter 6 Parameter Description

P00group :Basic parameters

Function code	Name	Functional code parameter specification	Unit	Factory Default	Property
P00.00	Control way	0: open loop vector 1: SVC vector		0	⊙

0: Open loop vector

Applicable to variable frequency control occasion which does not have much demand to load, multi-split, responsiveness and accuracy.

1: SVC vector

Applicable to general high-performance control occasion .When using vector control way ,you can have a parameter self-learning about motor in order to get correct motor parameters and improve the control performance .

Function code	Name	Functional code parameter specification	Unit	Factory Default	Property
P00.01	Command source selection	0: Machine' s keyboard 1: The external terminals 2: computer communication		0	⊙

0: local keypad

Control the start and stop of inverter from the RUN and STOP key on keypad.

1: external terminal

Perform command control by multifunctional input terminals, RUN, F/R, FJOG, RJOG and so on.

2: pc communication

Run command is provided by host computer by communication. Please refer to 《ES100A MODBUS Communication Protocol》。

Function code	Name	Functional code parameter specification	Unit	Factory Default	Property
P00.02	Main frequency source option	0: Main digital frequency given 1: Keypad potentiometer 2: AI1 3: AI2		1	⊙

0: Main digital frequency given

Main frequency is set by P00.08 function code.

1: Keypad potentiometer

Main frequency is given by keypad potentiometer.

2: AI1

Main frequency is given by AI1 terminal.

3: AI2

Main frequency is given by AI2 terminal.

Function code	Name	Functional code parameter specification	Unit	Factory Default	Property
P00.03	Auxiliary frequency source option	0: Auxiliary digital frequency 1: Keypad potentiometer 2: AI1 3: AI2 4: PLC 5: PID		0	⊙

0: Auxiliary digital frequency

Auxiliary frequency is set by P00.09 function code

1: Keypad potentiometer

Auxiliary frequency is given by keypad potentiometer

2: AI1

Auxiliary frequency is given by AI1 terminal

3: AI2

Auxiliary frequency is given by AI2 terminal

4: PLC program operation

Auxiliary frequency is given by PLC program operation function

5: PID

Auxiliary frequency is given by PID process PID function.

Function code	Name	Functional code parameter specification	Unit	Factory Default	Property
P00.04	Output frequency source option	0: Main frequency source 1: Auxiliary frequency source 2: Main+Auxiliary 3: Main-Auxiliary 4: MAX(main ,auxiliary) 5: MIN(main, auxiliary)		0	⊙

0: Main frequency source

Output frequency is decided by main frequency source.

1: Auxiliary frequency source

Output frequency is decided by auxiliary frequency source.

2: Main+Auxiliary

Output frequency is decided by main frequency source +auxiliary frequency source, and the complex frequency will not exceed upper limit frequency.

3: Main–Auxiliary

Output frequency is decided by main frequency source –auxiliary frequency source, and the complex frequency will not exceed upper limit frequency.

4: MAX(main ,auxiliary)

Output frequency is the maximum value of main and auxiliary frequency.

5: MIN(main, auxiliary)

Output frequency is the minimum value of main and auxiliary frequency.

Function code	Name	Functional code parameter specification	Unit	Factory Default	Property
P00.05	Auxiliary frequency source range in stacking	0: Relative to maximum frequency 1: Auxiliary frequency source proportion in stacking		0	☉
P00.06	Relative to main frequency	0.00 ~ 200.00	%	100.00	○

P00.05=0: Relative to maximum frequency

When output frequency choose main+ auxiliary or main–auxiliary ,Control range of auxiliary frequency is relative to maximum frequency .

P00.05=1: Auxiliary frequency source proportion in stacking

When output frequency choose main+ auxiliary or main–auxiliary ,Control range of auxiliary frequency is relative to main frequency .

P00.06: when main and auxiliary are superposition, the scaling factor of the auxiliary frequency.

Function code	Name	Functional code parameter specification	Unit	Factory Default	Property
P00.07	Output frequency source control	0: Output frequency source 1: AI1*Output frequency source 2: AI2*Output frequency source		0	☉

0: Output frequency source

Output frequency source proportion is fixed as100.00%

1: AI1*output frequency source

Output frequency source is decided by the range of AI1.

2: AI2*output frequency source

Output frequency source is decided by the range of AI2.

Function code	Name	Functional code parameter specification	Unit	Factory Default	Property
P00.08	Main digital frequency	0.00 ~ maximum frequency	Hz	0.00	○
P00.09	Auxiliary digital frequency	0.00 ~ maximum frequency	Hz	0.00	○

P00.08: Main digital frequency given value.

P00.09: Auxiliary digital frequency given value.

Function code	Name	Functional code parameter specification	Unit	Factory Default	Property
P00.10	Running direction setting	0: forward rotation 1: reverse rotation		0	○

0: forward rotation

1: reverse rotation

Motor' s running direction setting.

Function code	Name	Functional code parameter specification	Unit	Factory Default	Property
P00.11	Accelerate time 1	0.00 ~ 600.00	S	20.00	○
P00.12	Decelerate time 1	0.00 ~ 600.00	S	20.00	○

Accelerate time is the time frequency inverter takes to rise to maximum frequency from 0Hz.

Decelerate time is the time frequency inverter takes to lower to 0Hz from maximum frequency.



图 6-1 Acceleration and deceleration time

Function code	Name	Functional code parameter specification	Unit	Factory Default	Property
P00.13	Carrier frequency	2.000 ~ 10.000	KHz	4.000	○

By this function, we can adjust the PWM carrier frequency of inverter. High carrier frequency can properly reduce motor noise.

But, when carrier frequency reaches to a high level, temperature rising of motor decreases and wear of inverter increases; when carrier frequency is at a low level, high-order harmonic component of output current enlarge and motor temperature rising increases. Therefore, please properly set carrier frequency according to practical situations.

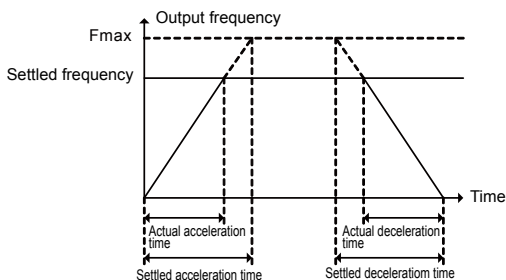
6

Function code	Name	Functional code parameter specification	Unit	Factory Default	Property
P00.14	Maximum frequency	20.00 ~ 600.00	Hz	50.00	◎
P00.15	Upper limit frequency	Lower limit frequency~maximum frequency	Hz	50.00	◎
P00.16	Lower limit frequency	0.00 ~ upper limit frequency	Hz	0.00	◎
P00.17	Lower limit frequency control	0: Running at lower limit frequency 1: Run at 0 speed after lower limit running time arrival		0	◎
P00.18	Lower limit frequency running time	0.00 ~ 600.00	S	60.00	◎

Maximum frequency:

The maximum frequency supported by frequency inverter.

Upper limit frequency :

During user usage ,the maximum frequency of motor allowed according to production technology.

Lower limit frequency :

During user usage, the minimum frequency of motor allowed according to production technology.

IF P00.17 is valid when set as 1,frequency inverter runs at lower limit frequency when its running frequency is lower than lower limit frequency .When running cumulative time exceed P00.18, frequency inverter operation at 0Hz. When operation frequency rises again and exceeds lower-limit frequency, if operation frequency lowers again and is lower than lower limit frequency, frequency inverter runs at lower limit frequency and runs at 0Hz .again after keeping the time.

Function code	Name	Functional code parameter specification	Unit	Factory Default	Property
P00.19	control of prohibit reverse rotation	0: Allow forward/reverse rotation 1: Forbiddan reverse rotation		0	⊙
P00.20	Positive/invert dead time	0.00 ~ 600.00	S	0.00	⊙

P00.19 control of prohibit reverse rotation

0: Allow forward/reverse rotation

Allow frequency inverter to output forward/reverse rotation.

1: Forbiddan reverse rotation

When output negative frequency, frequency inverter runs at 0Hz.

P00.20 Forward/Reverse rotation dead zone time

The time inverter stays in 0Hz when operation frequency of inverter changes from positive to negative, or from negative to positive.

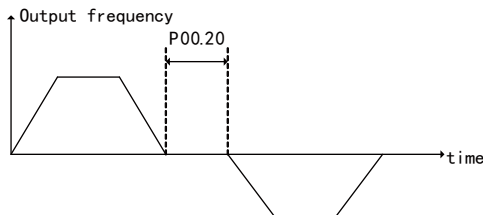

Fig 6-2 Diagram of forward/reverse rotation dead zone time

Function code	Name	Functional code parameter specification	Unit	Factory Default	Property
P00.21	Load velocity coefficient	0.01 ~ 300.00		30.00	○

Load speed coefficient is in proportional relation with output frequency and used to indicate load speed.

Function code	Name	Functional code parameter specification	Unit	Factory Default	Property
P00.22	Return to factory default	0: Invalid 1: return to factory default		0	◎

Return to frequency inverter's factory default and motor parameter will not return.

P01 group Start and stop control

Function code	Name	Functional code parameter specification	Unit	Factory Default	Property
P01.00	Accelerate/Decelerate mode	0: Linear mode 1: S curve mode		0	◎

P01.00=0: Linear mode

Frequency inverter's straight line accelerate/decelerate mode.

P01.00=1: S curve mode

frequency inverter's S curve accelerate/decelerate mode.

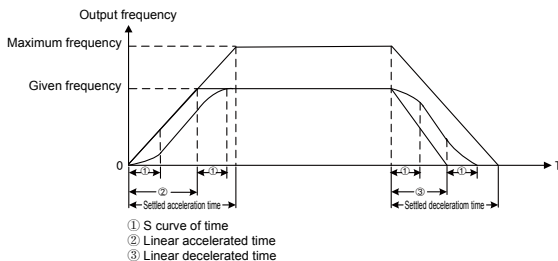

Fig 6-3 Diagram of straight and S curve accelerate/decelerate

Function code	Name	Functional code parameter specification	Unit	Factory Default	Property
P01.01	Start way	0: direct start 1: tracking start		0	◎

0: direct start

If P01.03: the time to start DC braking is set as 0, inverter is started by built-in 0Hz. It is applicable to the situation that motor is in stop status when start-up. If the time to start DC braking is not 0, DC braking first and then start with starting frequency; it is applicable to the situation that motor is under a small inertia load when start-up. Direct start way is shown in Fig 6-4. Left diagram is the case that the time to start DC braking is not 0; the right diagram is the case that the time to start DC braking is 0;

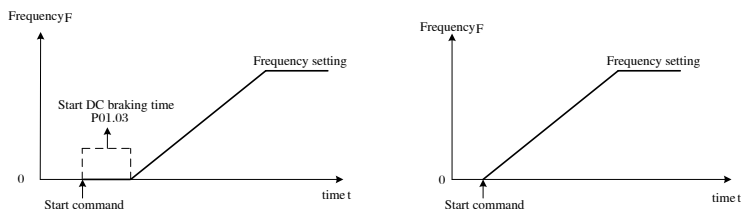

Fig 6-4 Diagram of direct start

1: rotational speed tracking start

When inverter is set as direct start and drives great inertia mechanical load, if instant power-cut occurs and inverter restarts, the load motor still continues running due to inertia and creates great energy feedback. In this case, inverter is likely to skip over overcurrent fault. Therefore, for this great inertia load drive, it is possible to set the inverter as rotational speed tracking start. It means when inverter starts up, it will automatically track the rotational speed and direction of motor, and then start up with motor frequency tracked. This way can embody smooth and shock-free start and avoid overcurrent at start. Diagram of this type of start is shown in Fig 6-5. Left diagram is the rotational speed tracking start diagram after load motor stops; right diagram is the rotational speed tracking start diagram in stop status.

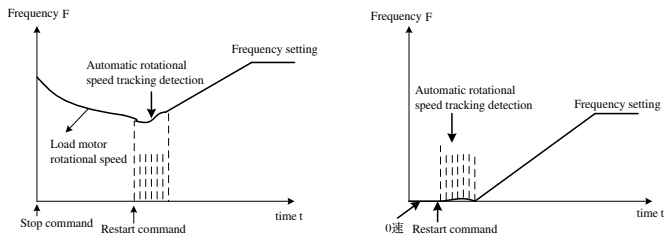

Figure 6-5 Trace startup diagram

Function code	Name	Functional code parameter specification	Unit	Factory Default	Property
P01.02	Start DC braking current	0.00 ~ 150.00	%	0.00	⊙
P01.03	Start DC braking time	0.00 ~ 30.00	S	0.00	⊙

P01.02 Start DC braking current:

Set the value of DC braking current, which is relative to the percentage of frequency inverter's rated current.

P01.03 Start DC braking time:

Set the action time of DC braking current.

Function code	Name	Functional code parameter specification	Unit	Factory Default	Property
P01.04	Stop method option	0: Stop in deceleration 1: Free stop		0	⊙

0: Stop in deceleration

Frequency inverter slows down and stop according to the set decelerate time.

1: Free stop

Frequency inverter blockades output immediately after receiving stop command and motor freely stops.

6

Function code	Name	Functional code parameter specification	Unit	Factory Default	Property
P01.05	Stop DC braking frequency	0.10 ~ upper limit frequency	Hz	2.00	⊙
P01.06	Stop DC braking current	0.00 ~ 150.00	%	0.00	⊙
P01.07	DC braking waiting time	0.01 ~ 30.00	S	0.5 0	⊙
P01.08	Stop DC braking time	0.00 ~ 30.00	S	0.00	⊙

P01.05: Stop DC braking frequency

During stop process, Start to input beginning frequency of braking current.

P01.06: Stop DC braking current

Set the value of braking current, which is relative to the percentage of frequency inverter's rated current.

P01.07: DC braking waiting time

Sealing time before inputting DC braking current.

P01.08: Stop DC braking time

Set the action time of DC braking current.

Function code	Name	Functional code parameter specification	Unit	Factory Default	Property
P01.09	Tracking beginning frequency	0: Maximum frequency 1: Outage frequency		1	⊙

P01.09: Tracking beginning frequency

If tracking enablement is chosen as enablement way(P01.01=1),frequency inverter will have rotational speed tracking according to parameter set by P01.09 when start. In order to track current motor' s operation frequency immediately ,please choose a appropriate way according to working condition.

P01.09=0: Begin to downward track from maximum frequency when motor' s operation situation totally uncertain(for example, motor has been in rotating status when frequency inverter electrifies) ;

P01.09=1: Begin to downward track from downtime frequency. Normally we choose this way;

Function code	Name	Functional code parameter specification	Unit	Factory Default	Property
P01.10~P01.21	Reserve				

P01.10~P01.21:Reserve

Function code	Name	Functional code parameter specification	Unit	Factory Default	Property
P01.22	terminal start up reconfirm	0:needless 1:needed		0	⊙

Inverter command source option is set as external terminal start. When powered up or fault reset, initial connection status of periphery devices may affect the safety of devices. By setting this parameter, protective measure is provided according to terminal startup.

P01.22=0: invalid

When powered up, terminal start control can directly turn on the machine.

P01.22=1: valid

When powered up, terminal start control needs to relieve valid signal of terminal start before starting up terminal.

Case 1: if terminal start command becomes valid when inverter is powered up (for example, it is closed state before powered up), inverter will not respond to operation command. It is a must to cancel operation command once and after terminal start command becomes valid again, inverter will respond to the operation command.

Case 2: when inverter is reset because of fault and terminal start command becomes valid,

inverter will not respond to start operation command. It is a must to cancel operation command first to clear operation protection status.

P02 group Motor parameter

Function code	Name	Functional code parameter specification	Unit	Factory Default	Property
P02.00	Motor rated power	0.10 ~ 600.00	KW	XX.XX	⊙
P02.01	Motor rated voltage	50 ~ 660	V	XXX	⊙
P02.02	Motor rated current	0.01 ~ 600.00	A	XX.X	⊙
P02.03	Motor rated frequency	20.00 ~ 600.00	Hz	XX.XX	⊙
P02.04	Motor rated rotational speed	1 ~ 60000	rpm	XXXX	⊙
P02.05	Motor connection way	0: Y 1: Δ		X	⊙
P02.06	Power factor	0.600 ~ 1.000		X.XX	⊙
P02.07	Motor efficiency	30.0 ~ 100.0	%	XX.XX	⊙

P02.00~P02.07 are set as drive motor parameter. Set according to motor nameplate parameter before use.

6

Function code	Name	Functional code parameter specification	Unit	Factory Default	Property
P02.08	No-load resistance	0.01 ~ 600.00	A	XX.X	⊙
P02.09	Stator resistance	1 ~ 60000	m Ω	XX.X	⊙
P02.10	Rotor resistance	1 ~ 60000	m Ω	XX.X	⊙
P02.11	Asynchronous machine mutual inductance	0.1 ~ 6000.0	mH	XXX.X	⊙
P02.12	Asynchronous machine leakage inductance	0.01 ~ 600.00	mH	X.XXX	⊙

P02.08~P02.12 are the values calculated after motor tuning.

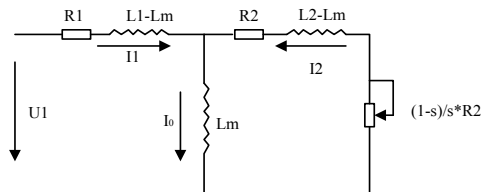

Fig 6-6 Asynchronous motor steady state and equivalent model

Function code	Name	Functional code parameter specification	Unit	Factory Default	Property
P02.13	Parameter self-identification	0: non-identification 1: Motor static self-identification 2: Motor rotating self-identification		0	⊙

After motor tuning ,P02.13 automatic be 0.

P03 group V/F control parameter group

Function code	Name	Functional code parameter specification	Unit	Factory Default	Property
P03.00	V/F curve setting	0: Straight line V/F curve 1: Multi-point V/F curve 2: Fan curve 1 3: Fan curve 2 4: Fan curve 3 5: Fan curve 4 6: VF complete separation mode		1	○

0: Straight line V/F curve

Applicable to the situation of constant torque load

1: Multi-point V/F curve

User-defined curve.

2~5: Fan curve

Applicable to the variable load situation of motors like fan and water pump .

6: VF complete separation mode

Output frequency and voltage of inverter is separately independent. Output frequency is determined by frequency source and output voltage ensuring VF complete separation mode is determined by P03.10(VF separation voltage), which is usually applied to induction heating, inverter, torque motor control and so on.

Function code	Name	Functional code parameter specification	Unit	Factory Default	Property
P03.01	Reservation				
P03.02	V/F voltage value V0	0.00 ~ 100.00	%	1.00	○
P03.03	V/F voltage value V1	0.00 ~ 100.00	%	4.00	○
P03.04	V/F voltage value V2	0.00 ~ 100.00	%	10.00	○
P03.05	V/F voltage value V3	0.00 ~ 100.00	%	16.00	○

P03.06	V/F frequency value F0	0.00 ~ Frequency values F1	%	1.00	○
P03.07	V/F frequency value F1	Frequency values F0 ~ Frequency values F2	%	4.00	○
P03.08	V/F frequency value F2	Frequency values F1 ~ Frequency values F3	%	10.00	○
P03.09	V/F frequency value F3	Frequency values F2 ~ 100.00	%	16.00	○

When F03.00=1, V/F curve can be adjusted by multi-point.

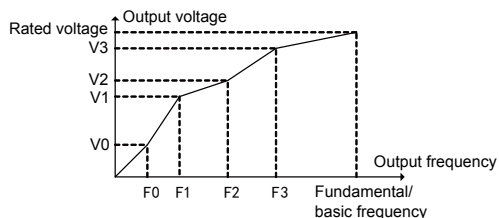

Fig 6-7 Diagram of multi-point V/F curve

6

Function code	Name	Functional code parameter specification	Unit	Factory Default	Property
P03.10	VF separated voltage source	0: Digital setting of VF separated voltage 1: Keypad potentiometer 2: AI1 3: AI2 4: PID		0	◎
P03.11	Voltage setting of VF separated digital	0.0 ~ 100.0	%	0.0	○
P03.12	Rising time of VF separated voltage	0.00 ~ 60.00	S	5.00	○

P03.10 = 0: Digital setting of VF separated voltage

V/F separated voltage control is given by P03.11, set range 0~100.00

P03.10 = 1: Keypad potentiometer

V/F separated voltage control is given by keypad potentiometer

P03.10 = 2: AI1

V/F separated voltage control is given by AI1

P03.10 = 3: AI2

V/F separated voltage control is given by AI2

P03.10 = 4: PID

V/F separated voltage control is given by PID
 P03.11: Voltage setting of VF separated digital
 When P03.10=0, V/F separated digital voltage is set by P03.11
 P03.12: Rising time of VF separated voltage
 V/F separated voltage's time to rise to 100% from 0

P04 group Input terminal control

Function code	Name	Functional code parameter specification	Unit	Factory Default	Property
P04.00	DI terminal wave filtering	0 ~ 100		10	○

Set the sensitivity of DI terminal. The greater the digital are ,the stronger capacity of anti-interference and lower sensitivity are.

Function code	Name	Functional code parameter specification						Unit	Factory Default	Property
		Bit5 X6	Bit4 X5	Bit3 X4	Bit2 X3	Bit1 X2	Bit0 X1			
P04.01	DI input logic	0: Close valid 1: Break valid							0000000	○

0:Close valid

Input terminal is valid for close and invalid for break.

1:Break valid

Input terminal is valid for break and invalid for close.

Function code	Name	Functional code parameter specification	Unit	Factory Default	Property
P04.02	X1 valid delay time	0.000 ~ 30.000	S	0.000	○
P04.03	X2 valid delay time	0.000 ~ 30.000	S	0.000	○

Delay time of X1 ,X2 input response.

Function code	Name	Functional code parameter specification	Unit	Factory Default	Property
P04.04	Multi-functional input X1	0: no function 1: run RUN 2: forward/reverse rotation F/R 3: 3-thread operation stop control		1	○

P04.05	Multi-functional input X2	4: forward rotation jog FJOG 5: reverse rotation jog RJOG 6: terminal UP	2	○
P04.06	Multi-functional input X3	7: terminal DOWN 8: UP / DOWN reset 9: free stop FRS 10: fault reset RST 11: external fault EXT	13	○
P04.07	Multi-functional input X4	12: Accelerate/Decelerate forbidden terminal 1 13: multi-segment frequency terminal 1 14: multi-segment frequency terminal 2 15: multi-segment frequency terminal 3	14	○
P04.08	Multi-functional input X5	16: Accelerate/Decelerate time switching 17: Operation command switching to terminal 18: Switching to Auxiliary velocity 19: Stop DC braking	15	○
P04.09	Multi-functional input X6	20: Program operation reset 21: Multi-segment torque terminal 1 22: Multi-segment torque terminal 2 23: PID parameter switching	10	○

Fig 6-1 Multi-functional input terminal function code table

set value	function	function description
0	no function	No response to external terminal signal.
1	run RUN	Control operation and stop by external terminals.
2	forward/reverse rotation F/R	Control forward/reverse rotation by external terminals.
3	3-thread operation stop control	The operation mode is effective for 3-thread control.
4	forward rotation jog FJOG	External terminal forward / reverse jog function.
5	reverse rotation jog RJOG	
6	terminal UP	Adjust setting frequency by external terminals.
7	terminal DOWN	

8	UP / DOWN reset	Clear the frequency value modified by UP/DOWN.		
9	9; free stop FRS	Inverter locks the output.		
10	fault reset RST	For fault reset when inverter comes into fault		
11	external fault EXT	When external fault signal becomes valid, inverter has fault.		
12	Accelerate/ Decelerate forbidden	Inverter maintains current output frequency.		
13	multi-segment frequency terminal 1	Embody 7-segment speeds setting through combination of 3 terminals.		
14	multi-segment frequency terminal 2			
15	multi-segment frequency terminal 3			
16	Accelerate/ Decelerate time switching	Embody 2 kinds of accelerate/decelerate time through the combination of 1 terminal.		
17	Operation command switching to terminal	When terminal function is valid, operation command is switched to terminal control.		
18	Switching to Auxiliary velocity	When terminal function is valid, frequency inverter is valid for switching to auxiliary speed.		
19	Stop DC braking	During stop process ,when DC braking is valid, the terminal' s valid time and DC braking time take the maximum.		
20	Program operation reset	When terminal function is valid ,program operation time and cycle times clear to 0 .Program operation begins from the first segment.		
21	Multi-segment torque terminal 1	Through these two terminals you can embody function of 4 segment torque given. Details are as follows in the table or see table 6-4. (0/1:current terminal is invalid/ valid)		
22	Multi-segment torque terminal 2	22	21	Multi-segment torque given
		0	0	Decided by torque given source option(15.01)
		0	1	Multi-segment torque) 1 (P15.10)
		1	0	Multi-segment torque) 2 (P15.11)
		1	1	Multi-segment torque) 3 (P15.12)
23	PID parameter switching	Be used to switch between PID parameter1 and parameter 2		

Function code	Name	Functional code parameter specification	Unit	Factory Default	Property
P04.10	Terminal command way	0: Two-thread control 1 1: Two-thread control 2 2: Three-thread control 1 3: Three-thread control 2		0	○

When terminal start/stop control mode is valid, frequency inverter's start/stop way can be controlled by terminal.

Two-thread control 1:

K1	K2	command
0	0	Stop control
1	0	Forward rotation(control)
0	1	Stop control
1	1	Reverse rotation(control)

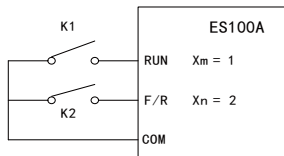

Fig 6-8 Two-thread control 1

Two-thread control 2:

K1	K2	command
0	0	Stop control
1	0	Forward rotation(control)
0	1	Reverse rotation(control)
1	1	Reservation

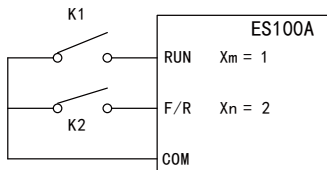

Fig 6-9 Two-thread control 2

Three-thread control 1:

SB1	Forward rotation(control)
SB2	Stop control
SB3	Reverse rotation(control)

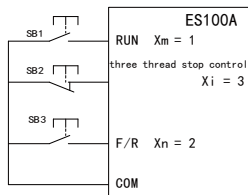

Fig 6-10 Three-thread control 1

Three-thread control 2:

SB1	Operation control
K1	Stop control
K2	Direction control

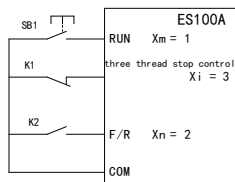

Fig 6-11 Three-thread control 2

Function code	Name	Set range	Unit	Factory Default	Property
P04.11	analog input curve option	Ones place: All curve option 0: curve 1(two point) 1: curve 2(two point) 2: curve 3(four point) 3: curve 4(four point) Tens place: AI2 curve option 0: curve 1(two point) 1: curve 2(two point) 2: curve 3(four point) 3: curve 4(four point) hundreds place: VP curve option 0: curve 1(two point) 1: curve 2(two point) 2: curve 3(four point) 3: curve 4(four point)		120D	○

Choose analog value AI and VP input curve.

Function code	Name	Set range	Unit	Factory Default	Property
P04.12	Curve 1 minimum input	0.00 ~ P04.14	V	0.1	○
P04.13	Curve 1 minimum input corresponding given	-100.0 ~ +100.0	%	0	○
P04.14	Curve 1 maximum input	P04.12 ~ 10.00	V	9.9	○
P04.15	Curve 1 maximum input corresponding given	-100.0 ~ +100.0	%	100	○
P04.16	Curve 2 minimum input	0.00 ~ P04.18	V	0.1	○
P04.17	Curve 2 minimum input corresponding given	-100.0 ~ +100.0	%	0	○
P04.18	Curve 2 maximum input	P04.16 ~ 10.00	V	9.9	○
P04.19	Curve 2 maximum input corresponding given	-100.0 ~ +100.0	%	100	○
P04.20	Curve 3 minimum input	0.00 ~ P04.22	V	0.1	○
P04.21	Curve 3 minimum input corresponding given	-100.0 ~ +100.0	%	0	○
P04.22	Curve 3 inflection 1 input	P04.20 ~ P04.24	V	2.5	○
P04.23	Curve 3 inflection 1 input corresponding given	-100.0 ~ +100.0	%	25	○
P04.24	Curve 3 inflection 2 input	P04.22 ~ P04.26	V	7.5	○
P04.25	Curve 3 inflection 2 input corresponding given	-100.0 ~ +100.0	%	75	○

P04.26	Curve 3 maximum input	P04.24 ~ 10.00	V	9.9	○
P04.27	Curve 3 maximum input corresponding given	-100.0 ~ +100.0	%	100	○
P04.28	Curve 4 minimum input	0.00 ~ P04.30	V	0.1	○
P04.29	Curve 4 minimum input corresponding given	-100.0 ~ +100.0	%	0	○
P04.30	Curve 4 inflection 1 input	P04.28 ~ P04.32	V	2.5	○
P04.31	Curve 4 inflection 1 input corresponding given	-100.0 ~ +100.0	%	25	○
P04.32	Curve 4 inflection 2 input	P04.30 ~ P04.34	V	7.5	○
P04.33	Curve 4 inflection 2 input corresponding given	-100.0 ~ +100.0	%	75	○
P04.34	Curve 4 maximum input	P04.32 ~ 10.00	V	9.9	○
P04.35	Curve 4 maximum input corresponding given	-100.0 ~ +100.0	%	100	○

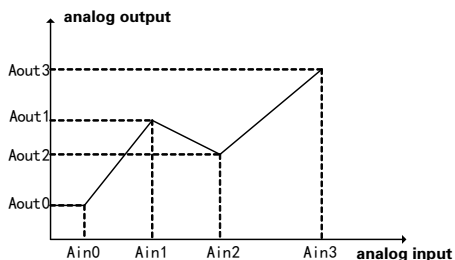

Fig 6-12 Analog input bias

Function code	Name	Set range	Unit	Factory Default	Property
P04.36	AI1 proportional gain	0.00 ~ 300.00	%	100	○
P04.37	AI2 proportional gain	0.00 ~ 300.00	%	100	○

Set AI1 AI2 proportional gain coefficient

Function code	Name	Set range	Unit	Factory Default	Property
P04.38	AI1 filtering time	0.00 ~ 10.00	s	0.1	○
P04.39	AI2 filtering time	0.00 ~ 10.00	s	0.1	○
P04.40	VP filtering time	0.00 ~ 10.00	s	0.1	○

Set AI1 AI2 VP filtering time

Function code	Name	Set range	Unit	Factory Default	Property
P04.41	AD Sampling Hysteresis	0 ~ 200		10	⊙

Set the AD Hysteresis parameter

Function code	Name	Set range	Unit	Factory Default	Property
P04.42	X1 Invalid delay time	0.000 ~ 30.000	s	0	○
P04.43	X2 Invalid delay time	0.000 ~ 30.000	s	0	○
P04.44	X3 Valid delay time	0.000 ~ 30.000	s	0	○
P04.45	X3 Invalid delay time	0.000 ~ 30.000	s	0	○
P04.46	X4 Valid delay time	0.000 ~ 30.000	s	0	○
P04.47	X4 Invalid delay time	0.000 ~ 30.000	s	0	○
P04.48	X5 Valid delay time	0.000 ~ 30.000	s	0	○
P04.49	X5 Invalid delay time	0.000 ~ 30.000	s	0	○
P04.50	X6 Valid delay time	0.000 ~ 30.000	s	0	○
P04.51	X6 Invalid delay time	0.000 ~ 30.000	s	0	○

Valid/Invalid delay time of input terminal response.

P05 group Output terminal control

Function code	Name	Functional code parameter specification	Unit	Factory Default	Property
P05.00	Multi-functional output Y1	0: frequency inverter operation 1: reverse rotation running 2: frequency arrival(FAR) 3: frequency level detection (FDT) 4: frequency inverter fault 5: upper limit frequency arrival 6: lower limit frequency arrival		0	⊙
P05.01	Relay output R1	7: ready for operation 8: frequency level detection FDT and JOG is invalid 9: overload pre-alarm Notes: Description of parameter is written in table 6-2		4	⊙

set value	function	function description
0	frequency inverter operation	Indicating frequency inverter is running.
1	reverse rotation running	frequency inverter current output is negative.
2	frequency arrival(FAR)	frequency output range is valid.
3	frequency level detection (FDT)	frequency output level is valid.
4	frequency inverter fault	output is valid when frequency inverter has fault.
5	upper limit frequency arrival	output is valid when running frequency arrives upper limit frequency.
6	lower limit frequency arrival	output is valid when running frequency arrives lower limit frequency.
7	ready for operation	Electrifying of frequency inverter has been prepared.
8	frequency level detection FDT and JOG is invalid	when frequency output level is valid ,frequency inverter will output valid signal.
9	overload pre-alarm	when current output current \geq overload pre-alarm detection level ,frequency inverter output is valid.

Table 6-2 Multi-functional output terminal function code table

Function code	Name	Functional code parameter specification	Unit	Factory Default	Property
P05.02	Analog output AO	AO programming code is shown in table 6-3		0	○

set value	function	function description
0	Operation frequency	0 ~ maximum frequency
1	Set frequency	0 ~ maximum frequency
2	Output current	0 ~ 2 twice of frequency inverter rated current
3	Output voltage	0 ~ 1.5 times of frequency inverter rated voltage
4	Busbar voltage	0 ~ 1.5 times of rated busbar voltage
5	AI1	0.00 ~ 10.00V
6	AI2	0.00 ~ 10.00V
7	+10V	+10V
8	Reservation	

Fig 6-3 Multi-functional analog value output function code table

Function code	Name	Functional code parameter specification	Unit	Factory Default	Property
P05.03	AO output lower limit	0.00 ~ 100.00	%	0.00	○
P05.04	AO output upper limit	0.00 ~ 100.00	%	100.00	○
P05.05	AO output gain	0.00 ~ 300.00	%	100.00	○

Bias function of analog output.

Function code	Name	Functional code parameter specification	Unit	Factory Default	Property
P05.06	FDT upper bound	0.00 ~ maximum frequency	Hz	30.00	⊙
P05.07	FDT lower bound	0.00 ~ maximum frequency	Hz	30.00	⊙

Level function of FDT frequency output.



图 6-13 FDT frequency output level

Function code	Name	Functional code parameter specification	Unit	Factory Default	Property
P05.08	FAR Output frequency	0.00 ~ 20.00	Hz	2.50	○

FAR frequency output range arrives.

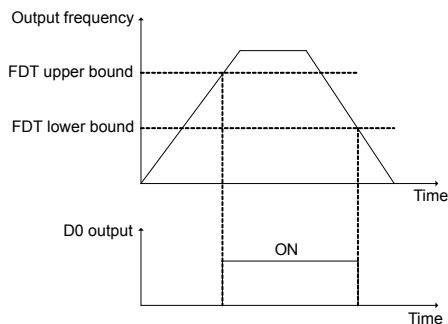
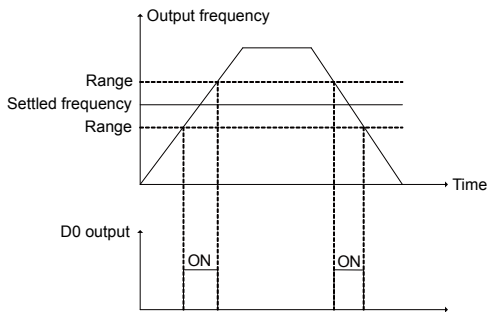

Figure 6-14 FAR frequency output level

P06 group Auxiliary parameter

Function code	Name	Functional code parameter specification	Unit	Factory Default	Property
P06.00	Jog digital frequency	0.00 ~ maximum frequency	Hz	5.00	○
P06.01	Jog accelerate time	0.00 ~ 600.00	S	20.00	○
P06.02	Jog decelerate time	0.00 ~ 600.00	S	20.00	○

P06.00: Jog digital frequency

Reference frequency given of jog control

P06.01: Jog accelerate time

The time frequency takes to rise to maximum frequency from 0Hz when jog control.

P06.02: Jog decelerate time

The time frequency takes to lower to 0Hz from maximum frequency when jog control.

Function code	Name	Functional code parameter specification	Unit	Factory Default	Property
F06.03	Accelerate time 2	0.00 ~ 600.00	S	20.00	○
F06.04	Decelerate time 2	0.00 ~ 600.00	S	20.00	○

The second segment accelerate/decelerate time.

6

Function code	Name	Functional code parameter specification	Unit	Factory Default	Property
P06.05	Multi-segment velocity 1	0.00 ~ maximum frequency	Hz	0.00	○
P06.06	Multi-segment velocity 2	0.00 ~ maximum frequency	Hz	5.00	○
P06.07	Multi-segment velocity 3	0.00 ~ maximum frequency	Hz	10.00	○
P06.08	Multi-segment velocity 4	0.00 ~ maximum frequency	Hz	15.00	○
P06.09	Multi-segment velocity 5	0.00 ~ maximum frequency	Hz	20.00	○
P06.10	Multi-segment velocity 6	0.00 ~ maximum frequency	Hz	25.00	○
P06.11	Multi-segment velocity 7	0.00 ~ maximum frequency	Hz	30.00	○

Set value of multi-segment frequency.

Defined table of multi-segment velocity terminal				
Function code	Name	X5	X4	X3
P06.05	Multi-segment velocity 1	0	0	1
P06.06	Multi-segment velocity 2	0	1	0
P06.07	Multi-segment velocity 3	0	1	1
P06.08	Multi-segment velocity 4	1	0	0
P06.09	Multi-segment velocity 5	1	0	1
P06.10	Multi-segment velocity 6	1	1	0
P06.11	Multi-segment velocity 7	1	1	1

Function code	Name	Functional code parameter specification	Unit	Factory Default	Property
P06.12	UP/DOWN frequency rate	0.00 ~ 100.00 0.00 (Automatic rate)		1.00	○

UP/DOWN rate of control

Function code	Name	Functional code parameter specification	Unit	Factory Default	Property
P06.13	Storage of power down	0: Non storage the frequency of before power down 1: Storage the frequency of before power down 2: UP/DOWN downtime and clear		0	◎

Storage control of frequency power down .

Function code	Name	Functional code parameter specification	Unit	Factory Default	Property
P06.13	Monitoring parameter of keypad second line	0 ~ 20 (P13.00 ~ P13.18)		4	◎

Frequency inverter' s monitoring parameter when in the status of running and standby.

P07 group Communication function

Function code	Name	Functional code parameter specification	Unit	Factory Default	Property
P07.00	Local address	0: Broadcast address 1 ~ 247		1	◎

0 is broadcast address and 1~247 can be set as local communication address.

Function code	Name	Functional code parameter specification	Unit	Factory Default	Property
P07.01	Communication wave rate	0: 4800 1: 9600 2: 19200 3: 38400	bps	1	○
P07.02	Communication format	0: no check 1+8+1 1: even parity check 1+8+1+1 2: odd parity check 1+8+1+1		0	○

Wave rate supports 4800~38400bps.Data format supports 0~2 in total 3 kinds.

Function code	Name	Functional code parameter specification	Unit	Factory Default	Property
P07.03	Communication overtime time	0.0 ~ 60.0 0.0 function invalid when communication overtime	S	0.0	○

Communication overtime detection time.

Function code	Name	Functional code parameter specification	Unit	Factory Default	Property
P07.04	Communication way of host and slave	0: Local machine is slave 1: Local machine is host	S	0	○
P07.05	Host write slave's address	0: Main digital frequency 1: Auxiliary digital frequency		0	○
P07.06	Proportion coefficient of local machine receiving	0.00 ~ 300.00	%	100.00	○
P07.07	Host communication sends data	0: Output frequency 1: Set frequency 2: Main digital frequency 3: Keypad potentiometer 4: AI1 5: AI2		0	○

Frequency inverter local machine can be chosen as

communication host or slave ,and when it is chosen as host, it can choose to send data

automatically. When it is chosen as slave ,it can choose data received storage address and proportion coefficient.

P08 group PID control function

Function code	Name	Functional code parameter specification	Unit	Factory Default	Property
P08.00	PID given source	0: Digital given 1: AI1 2: AI2		0	⊙
P08.01	PID digital given	0.0 ~ P08.03 PID maximum scale	%	50.0	○
P08.02	PID feedback source	0: AI1 1: AI2		0	⊙
P08.03	PID maximum scale	0.1 ~ 6000.0		100.0	○

PID control function given and feedback signal source.

Function code	Name	Functional code parameter specification	Unit	Factory Default	Property
P08.04	PID action direction	0: Positive action 1: Negative action		0	⊙

0: Positive action

Frequency inverter's output frequency must be lower so that the PID can get balance when feedback signal is bigger than PID given.

1: Negative action

Frequency inverter's output frequency must rise so that the PID can get balance when feedback signal is bigger than PID given.

Function code	Name	Functional code parameter specification	Unit	Factory Default	Property
P08.05	PID output gain	0.00 ~ 100.00	%	100.00	○

Proportion coefficient of PID output.

Function code	Name	Functional code parameter specification	Unit	Factory Default	Property
P08.06	Proportion gain Kp	0.00 ~ 100.00		0.40	○
P08.07	Integral time Ti	0.000 ~ 30.000, 0.000: no integral	S	2.000	○
P08.08	Differential time Td	0.000 ~ 30.000, 0.000: no differential	mS	0.000	○

PID function's proportion, integral and differential parameter.

Function code	Name	Functional code parameter specification	Unit	Factory Default	Property
P08.09	Integral effect range	0.00 ~ 100.00	%	100.00	○

Integral effect range indicates when error of given and feedback is bigger than some set values ,it will have no more integral operation.

Function code	Name	Functional code parameter specification	Unit	Factory Default	Property
P08.10	PID deviation limit	0.00 ~ 100.00	%	0.00	○

PID stops adjusting when PID' s error is in the range.

Function code	Name	Functional code parameter specification	Unit	Factory Default	Property
P08.11	PID output upper limit	PID output lower limit ~ 100.0	%	100.0	○
P08.12	PID output lower limit	-100.0 ~ PID output lower limit	%	0.0	○

Limit range of PID output .

Function code	Name	Functional code parameter specification	Unit	Factory Default	Property
P08.13	PID Disconnection detection value of PID feedback	0.00 ~ 100.00	%	0.0	○
P08.14	PID Disconnection detection time of PID feedback	0.0 ~ 30.0	S	1.0	○

When PID feedback value is small than lost detection value P08.13 and continuous time is more than PID feedback lost detection time P08.14 ,frequency inverter reports PID feedback disconnection fault.

Function code	Name	Functional code parameter specification	Unit	Factory Default	Property
P08.15	Start threshold value	0.00 ~ sleep threshold	%	0.0	○
P08.16	Start delay time	0.0 ~ 30.0	S	0.0	○

P08.17	Sleep threshold	Start threshold value ~ 100.00	%	100.00	○
P08.18	Sleep delay time	0.0 ~ 30.0	S	0.0	○

P08.15 Start threshold value

After frequency inverter be in sleep status ,PID feedback value must be lower than start threshold so that frequency inverter can restart.

P08.17 Sleep threshold

When frequency inverter detect that PID feedback value is bigger than sleep threshold ,frequency inverter gradually lowers outpour frequency until to the lower limit frequency. After running a period of time at lower limit frequency, frequency inverter lowers to 0HZ and gets into sleep status.

Function code	Name	Functional code parameter specification	Unit	Factory Default	Property
P08.19	PID given variety time	0.000 ~ 30.000	S	0.000	○

PID given variety time indicates time given takes to vary from 0.0% to 100%.

Function code	Name	Functional code parameter specification	Unit	Factory Default	Property
P08.20	PID feedback filtering time	0.000 ~ 30.000	S	0.000	○
P08.21	PID output filter time	0.000 ~ 30.000	S	0.000	○

P08.20: Be used to have filtering the PID feedback value.

P08.21: Be used to have filtering the PID output value.

Function code	Name	Functional code parameter specification	Unit	Factory Default	Property
P08.22	Proportion gain 2	0.00 ~ 100.00		0.40	○
P08.23	Integral time 2	0.000 ~ 30.000, 0.000; no integral	S	10.000	○
P08.24	Differential time 2	0.000 ~ 30.000	MS	0.000	○
P08.25	PID parameter switching conditions	0: no switching 1: Through terminal switching of digital input 2: Automatic switch according to deviation		0	○
P08.26	PID parameter switching deviation 1	0.00 ~ P08.27	%	20.00	○
P08.27	PID parameter switching deviation 2	P08.26 ~ 100.00	%	80.00	○

In order to satisfy various complex occasions, process PID modular introduce two groups of PID parameter, which can have a linear interpolation and switch between two groups of parameter according to functional setting (P08.25) and input condition.

Function code	Name	Functional code parameter specification	Unit	Factory Default	Property
P08.28	PID initial value	0.00 ~ 100.00	%	0.00	○
P08.29	PID initial value continuous time	0.00 ~ 650.00	S	0.00	○

Set PID initial value and continuous time.

P09 group Simple PLC function

Function code	Name	Functional code parameter specification	Unit	Factory Default	Property
P09.00	PLC operation way	0: Downtime after single operation 1: Downtime after finishing limit cycle 2: Operation at seventh segment after single operation 3: Cycle operation		0	◎

0: Downtime after single operation

Automatic downtime after finishing operation according to set running velocity and time.

1: Downtime after finishing limit cycle

Automatic downtime after cycle times of P09.10

2: Operation at seventh segment speed after single operation

Operation at seventh segment speed after finishing operation according to set running velocity and time.

3: Cycle operation

Recycle operation after finishing operation according to set running velocity and time.

Function code	Name	Functional code parameter specification	Unit	Factory Default	Property
P09.01	PLC operation control	0: Begin to operate at interruption period 1: Start operating at the beginning		0	◎

0:Begin to operate from interruption period.

After the interruption of PLC operation ,start to continue to operate at the interrupted segment speed and operation time.

1:Start operating at the beginning

After the interrupted of PLC operation ,start to operate at the beginning.

Function code	Name	Functional code parameter specification	Unit	Factory Default	Property														
P09.02	PLC running direction	<table border="1"> <tr> <td>Bit6</td><td>Bit5</td><td>Bit4</td><td>Bit3</td><td>Bit2</td><td>Bit1</td><td>Bit0</td> </tr> <tr> <td>T7</td><td>T6</td><td>T5</td><td>T4</td><td>T3</td><td>T2</td><td>T1</td> </tr> </table> <p>0: Forward rotation 1: Reverse rotation</p>	Bit6	Bit5	Bit4	Bit3	Bit2	Bit1	Bit0	T7	T6	T5	T4	T3	T2	T1		000000	○
Bit6	Bit5	Bit4	Bit3	Bit2	Bit1	Bit0													
T7	T6	T5	T4	T3	T2	T1													
P09.03	Program operation time T1	0 ~ 60000	S	30	○														
P09.04	Program operation time T2	0 ~ 60000	S	30	○														
P09.05	Program operation time T3	0 ~ 60000	S	30	○														
P09.06	Program operation time T4	0 ~ 60000	S	30	○														
P09.07	Program operation time T5	0 ~ 60000	S	30	○														
P09.08	Program operation time T6	0 ~ 60000	S	30	○														
P09.09	Program operation time T7	0 ~ 60000	S	30	○														
P09.10	Program cycle times	1 ~ 30000		1	○														

The set of operation direction and time parameter of PLC program.

P10 group Fault and protection

Function code	Name	Functional code parameter specification	Unit	Factory Default	Property
P10.00	Motor overload protection	0: Invalid 1: Valid		0	⊙
P10.01	Reservation				

Motor overload protection function will provide inverse time limit curve and judge whether the motor overload or not .

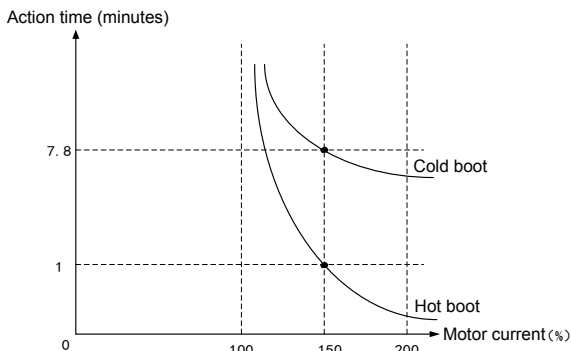

Fig 6-15 Motor overload protection

Function code	Name	Functional code parameter specification	Unit	Factory Default	Property
P10.02	Over-current stall protection	0: Invalid 1: mode 1 2: mode 2		2	⊙
P10.03	Limit current level	50.0 ~ 180.0	%	150.0	⊙

P10.02=0: over-current stall invalid

P10.02=1: over-current mode 1

P10.02=2: over-current mode 2

Current amplitude limiting function can prevent the frequency inverter' s output current from exceeding current amplitude limiting level.

Function code	Name	Functional code parameter specification	Unit	Factory Default	Property
P10.04	Over-voltage stall protection	0: Invalid 1: Over-voltage stall is valid		1	○
P10.05	Stall over-voltage point	380V: 640 ~ 800 220V: 370 ~ 400	V	720	○
				390	

P10.04=0: over-voltage stall invalid

P10.04=1: over-voltage stall valid

Function code	Name	Functional code parameter specification	Unit	Factory Default	Property
P10.06	Fault retry control	0: Invalid for fault retry 1 ~ 3: Fault retry 1、2、3 times 4: Infinite fault retry		00	○
P10.07	Fault output option during fault retry	0: no action 1: action		0	○
P10.08	Fault retry interval	0.01 ~ 30.00	S	0.50	○
P10.09	No fault interval	0.01 ~ 30.00	S	10.00	○

When frequency inverter appears fault ,this function is used to fault automatic reset.

Function code	Name	Functional code parameter specification	Unit	Factory Default	Property										
P10.10	Fault retry option	<table border="1"> <tr> <td>Bit4</td> <td>Bit3</td> <td>Bit2</td> <td>Bit1</td> <td>Bit0</td> </tr> <tr> <td>ERR07</td> <td>ERR05</td> <td>ERR04</td> <td>ERR03</td> <td>ERR02</td> </tr> </table>	Bit4	Bit3	Bit2	Bit1	Bit0	ERR07	ERR05	ERR04	ERR03	ERR02		00000	○
		Bit4	Bit3	Bit2	Bit1	Bit0									
ERR07	ERR05	ERR04	ERR03	ERR02											
0: Invalid for fault retry 1: Valid for fault retry															

Be used to set some faults can automatic retry valid after appearing fault.

Function code	Name	Functional code parameter specification	Unit	Factory Default	Property								
P10.11	Fault screening	<table border="1"> <tr> <td>Bit7</td> <td>Bit6</td> <td>Bit5</td> <td>Bit4</td> </tr> <tr> <td>*</td> <td>ERR15</td> <td>ERR12</td> <td>ERR07</td> </tr> </table>	Bit7	Bit6	Bit5	Bit4	*	ERR15	ERR12	ERR07		1111 1101	○
		Bit7	Bit6	Bit5	Bit4								
		*	ERR15	ERR12	ERR07								
		<table border="1"> <tr> <td>Bit3</td> <td>Bit2</td> <td>Bit1</td> <td>Bit0</td> </tr> <tr> <td>ERR10</td> <td>ERR06</td> <td>ERR05</td> <td>ERR04</td> </tr> </table>	Bit3	Bit2	Bit1	Bit0	ERR10	ERR06	ERR05	ERR04			
Bit3	Bit2	Bit1	Bit0										
ERR10	ERR06	ERR05	ERR04										
0: Protection invalid 1: Protection valid													

Be used to set some fault can have no detection and frequency inverter will keep running instead of alarming when appears this fault.

Function code	Name	Functional code parameter specification	Unit	Factory Default	Property
P10.12	Overload pre-alarm option	0: Y terminal outputs and keeps running 1: Fault alarmed and stop (ERR07)		0	○
P10.13	Overload pre-alarm detection level	20.00 ~ 200.00	%	130.00	○
P10.14	Overload pre-alarm detection time	0.0 ~ 60.0	S	5.0	○

If current output current \geq overload pre-alarm detection level(P10.13) and keeps detection time(P10.14), current output(P10.12) is valid .Otherwise ,current output is invalid.

Function code	Name	Functional code parameter specification	Unit	Factory Default	Property
P10.15	Power compensation factor	0.00 ~ 300.00	%	110	○

Used for corrected display power

6

P11 group Control parameter

Function code	Name	Functional code parameter specification	Unit	Factory Default	Property
P11.00	Fan control	0: operation when power on 1: start operation		1	○

0: operation when power on

After frequency inverter electrified ,fan begin to operate immediately.

1:start operation

When frequency inverter is in output valid status ,fan begin to operate immediately.

Function code	Name	Functional code parameter specification	Unit	Factory Default	Property
P11.01	Carrier way	0: Fixed carrier 1: Random carrier		0	○
P11.02	Carrier upper limit	P11.03 ~ 10.00	KHz	6.000	○
P11.03	Carrier lower limit	2.000 ~ P11.02	KHz	2.000	○

Frequency control way of PWM carrier.

Function code	Name	Functional code parameter specification	Unit	Factory Default	Property
P11.04	Automatic stabilivolt AVR	0: Invalid 1: Valid		1	○

0:Invalid

Invalid for automatic stabilivolt

1:Valid

Valid for automatic stavilivolt

Function code	Name	Functional code parameter specification	Unit	Factory Default	Property
P11.05	Energy consumption braking control	0: Invalid 1: Valid		1	○
P11.06	Braking usage rate	5.00 ~ 100.00	%	100.00	○
P11.07	Energy braking voltage	380V: 640 ~ 800 220V: 350 ~ 400	V	690	○
				380	

Control parameter of frequency inverter' s energy consumption braking.

Function code	Name	Functional code parameter specification	Unit	Factory Default	Property
P11.09	Over modulation function	0: Invalid 1: Valid		0	○

When frequency inverter' s input voltage is lower than output voltage ,through setting P11.09 be 1 can improve the availability of busbar voltage and enlarge the upper limit of output voltage.

Function code	Name	Functional code parameter specification	Unit	Factory Default	Property
P11.10	Oscillation inhibition gain	0 ~ 100		5	○

When open loop vector control, this parameter is mainly used to control motor oscillation. When there is no motor oscillation, try not to adjust this parameter. or you can appropriately turn down the parameter. When there is motor oscillation, properly increase the value of this parameter.

Function code	Name	Functional code parameter specification	Unit	Factory Default	Property
P11.11	V/F Slip compensation gain	0.00 ~ 200.00	%	100.00	○

With the increasing of load ,motor rotor' s speed gradually decreases. In order to ensure that motor' s rotor rotational speed close to synchronous speed in the status of rate load ,deviation compensation can be used. When motor' s rotational speed is lower than aimed value, you can enlarge the set value of P11.11.When P11.11=0,slip compensation is invalid and this parameter is valid for asynchronous motor only.

Function code	Name	Functional code parameter specification	Unit	Factory Default	Property
P11.12	Compensation gain of V/ F stator pressure drop.	0.00 ~ 200.00	%	100.00	○

Be used to compensate stator resistance and the voltage drop caused by wires ,which can improve the loading capacity of low frequency .

Function code	Name	Functional code parameter specification	Unit	Factory Default	Property
P11.13	Dead zone compensation	0: Invalid 1: Valid		1	◎

This parameter usually don' t need to modify. Valid dead zone compensation often can make output wave form more close to sine wave so that the motor can operate smoother.

Function code	Name	Functional code parameter specification	Unit	Factory Default	Property
P11.14	Flux braking gain	100 ~ 150 (100: no flux braking)		100	◎
P11.15	Reservation				

When flux braking is valid(O11.14 > 100),frequency inverter can make motor decelerate speedily through the method of increasing motor' s magnetic flux ,and electrical energy may turn to heat energy during the process of motor braking.

Choose flux braking action can speedily achieve decelerate ,but output current may be greater. Limit protection can be set by flux braking gain in order to protect motor .When choose flux braking no action ,decelerate time will be longer ,but output current will be lesser.

Function code	Name	Functional code parameter specification	Unit	Factory Default	Property
P11.16	Wave filtering time of V/F slip gain	0.00 ~ 10.00	S	1.00	◎

When motor has large inertia load and start speedily ,motor' s deviation is 100%.When motor arrives set frequency, deviation is 0 and output frequency will decrease speedily. This will cause over-voltage or over-current. Slip compensation filtering of P11.16 can restrain voltage and current from rising.

Function code	Name	Functional code parameter specification	Unit	Factory Default	Property
P11.17	Cut-off frequency of concussion inhibition	0.00 ~ 600.00	Hz	55.00	○

When open loop vector control, this parameter is mainly used to control motor oscillation. When there is no motor oscillation, try not to adjust this parameter. or you can appropriately turn down the parameter. When there is motor oscillation, properly increase the value of this parameter.

P12 group Keypad and display

Function code	Name	Functional code parameter specification	Unit	Factory Default	Property
P12.00	User' s password	0 ~ 65535		XXXXXX	○

Be used to set user' s password to prevent frequency inverter' s parameter from modifying by unrelated person. When new password is set as 0 ,password function is invalid. When password is set as user' s password except 0,besides local function code ,all the parameter can be referred only and can not be modified .

Function code	Name	Functional code parameter specification	Unit	Factory Default	Property
P12.01	Parameter setting control	0: Allow parameter setting 1: Parameter locking 0 2: Parameter locking 1		0	○

0: Allow parameter setting

All the parameters can be modified

1: Parameter locking 0

Can modify main digital frequency setting only

2:Parameter locking 1

All the parameters can not be modified.

Function code	Name	Functional code parameter specification	Unit	Factory Default	Property
P12.02	Parameter modification way	0: Keypad and communication are valid at the same time 1: Valid for keypad 2: Valid for communication		0	○

0:Keypad and communication are valid at the same time

Allow modifying the frequency inverter' s parameter through keypad and communication.

1:Valid for keypad

Keypad modifies parameter only

2:Valid for communication

Communication modifies parameter only

Function code	Name	Functional code parameter specification	Unit	Factory Default	Property
P12.03	Definition of multi-functional key	0: Invalid 1: Jog operation 2: Forward/Reverse rotation switching		1	⊙

0:Invalid

Multi-functional key is invalid

1:Jog operation

Multi-functional key has JOG operation function

2:Forward/Reverse rotation switching

Multi-functional key has the function of switching between forward rotation and reverse rotation.

Function code	Name	Functional code parameter specification	Unit	Factory Default	Property
P12.04	Code option of stop monitoring	0 ~ 17; P13.00 ~ P13.17		0	⊙
P12.05	Monitoring code option	0 ~ 17; P13.00 ~ P13.17		1	⊙

Frequency inverter' s monitoring parameter when in the status of running and standby.

Function code	Name	Functional code parameter specification	Unit	Factory Default	Property
P12.06	Frequency inverter running time	0 ~ 65535	HOURL	XXXXX	×
P12.07	Frequency inverter running time	0 ~ 59	Min	XX	×

Record accumulated operation time of frequency inverter.

Function code	Name	Functional code parameter specification	Unit	Factory Default	Property
P12.08	Operation time control	0: Invalid 1: Valid		0	⊙

P12.09	Set operation time	0 ~ 65535	HOUR	XXXXX	⊙
P12.10	Control password of operation time	0 ~ 65535		XXXXX	⊙

Frequency inverter' s control function of timed downtime.

Function code	Name	Functional code parameter specification	Unit	Factory Default	Property
P12.11	Frequency inverter rated power		kW	XXXX	×
P12.12	Frequency inverter rated voltage		V	XXX	×
P12.13	Frequency inverter rated current		A	XXXXX	×

Frequency inverter' s nameplate parameter.

Function code	Name	Functional code parameter specification	Unit	Factory Default	Property
P12.14	Software version			X.XX	×

Frequency inverter software version.

Function code	Name	Functional code parameter specification	Unit	Factory Default	Property
P12.15	Manufacturer password	0 ~ 65535		XXXXX	⊙

Factory internal parameter.

P15 group Torque control

Function code	Name	Functional code parameter specification	Unit	Factory Default	Property
P15.00	Speed/torque control option	0: Speed control 1: Torque control		0	⊙

P15.00=0: speed control

Control method is speed input ,and input value is frequency.

P15.00=1: torque control

Input control way is torque input, and input value is the percentage of motor rated torque current. When P00.00=1 ,torque control react.

Function code	Name	Functional code parameter specification	Unit	Factory Default	Property
P15.01	Torque given source option	0: Digital torque given P15.02 1: AI1 2: AI2 keypad potentiometer(Full scale is relative to digital torque given of P15.02)		0	⊙
P15.02	Digital torque given	-200.0 ~ 200.0 (100.0= motor rated torque)	%	100.0	○

Set given source of torque

Function code	Name	Functional code parameter specification	Unit	Factory Default	Property
P15.03	Accelerate/Decelerate time of torque control	0.00 ~ 120.00	S	0.05	○

6

Through setting accelerate/decelerate time of torque control can make motor' s rotational speed vary smoothly.

Function code	Name	Functional code parameter specification	Unit	Factory Default	Property
P15.04	Upper limit frequency option of torque control	0: Set by P15.05 1: AI1 2: AI2 3: keypad potentiometer		0	⊙
P15.05	Upper limit of torque control	0.00 ~ maximum frequency P00.14	Hz	50.00	○
P15.06	Upper limit frequency bias	0.00 ~ maximum frequency P00.14	Hz	0.00	○

Set upper limit frequency option and upper limit frequency when torque control.

Function code	Name	Functional code parameter specification	Unit	Factory Default	Property
P15.07	Torque compensation of static friction	0.0 ~ 100.0	%	0.0	○

P15.08	Compensated frequency range of static friction	0.00 ~ 50.00	Hz	1.00	○
P15.09	Torque compensation of dynamic friction	0.0 ~ 100.0	%	0.0	○

This group of parameter can control the output performance of motor.

Function code	Name	Functional code parameter specification	Unit	Factory Default	Property
P15.10	Multi-segment torque 1	-200.0 ~ 200.0	%	0.0	○
P15.11	Multi-segment torque 2	-200.0 ~ 200.0	%	0.0	○
P15.12	Multi-segment torque 3	-200.0 ~ 200.0	%	0.0	○

In order to embody diversified torque operation ,ES100A series frequency inverters support multi-segment torque function. If need to embody this function ,please set input terminal function” 21:multi-segment torque terminal 1” and “22: multi-segment torque terminal 2” .Details seen table 6-4.

Table 6-4 Combined description of multi-segment torque instruction and multi-segment torque terminal

22: multi-segment torque terminal 2	21: multi-segment torque terminal 1	Segments	Torque given
Invalid (0)	Invalid (0)	Multi-segment torque 1	Set by P15.01
Invalid (0)	Valid (1)	Multi-segment torque 2	P15.10
Valid (1)	Invalid (0)	Multi-segment torque 3	P15.11
Valid (1)	Valid (1)	Multi-segment torque 4	P15.12

Function code	Name	Functional code parameter specification	Unit	Factory Default	Property
P15.13	Limit option of reverse speed	0 ~ 100	%	100	×
P15.14	Preferential enabling of torque control velocity	0: Can not enable 1: Can enable		0	×

Torque is used to control frequency inverter’ s forward/reverse maximum operation frequency when upper-limit frequency is used to set torque control way.

Chapter 7 Fault diagnosis and elimination

7.1 Fault alarm and countermeasure

ES100A series compact vectorial inverter provides 20 alarm messages and protection functions. Once a fault occurs, protection function acts, inverter stops output, inverter fault relay R1 acts and shows fault code on the display of inverter. When a fault occurs during usage, user can refer to list 7-1, analyze the cause of fault and find out solution in a short time. If a fault remains, please contact your distributor or us.

Note: when a fault occurs during operation of motor, free stop will be enabled until motor stops.

Table 7-1 frequency inverter fault alarm and countermeasures self-check table

Fault code	Explanation	Possible reasons	Solutions
ERR00	trouble-free	/	/
ERR01	Inverter unit fault	<ol style="list-style-type: none"> 1. Short circuit between output side phases or to the ground. 2. Connection between motor and inverter is too long. 3. Inverter module is damaged 	<ol style="list-style-type: none"> 1. Eliminate peripheral short circuit fault. 2. Shorten connection and install an electric reactor or output filter. 3. Seek for technical support and replace module.
ERR02	Over-current fault	<ol style="list-style-type: none"> 1. Short circuit between output side phases or to the ground. 2. Load is increased suddenly during operation or acceleration/ deceleration time is too short. 3. V/F torque boost setting is excessive. 4. Motor is in rotation state upon start-up. 5. Motor capacity is higher than inverter's. 	<ol style="list-style-type: none"> 1. Eliminate peripheral short-circuit fault. 2. Remove sudden load or reset acceleration/ deceleration time. 3. Reset V/F torque boost value. 4. Start rotational speed tracking function. 5. Replace appropriate motor or inverter
ERR03	Over-voltage fault	<ol style="list-style-type: none"> 1. Input voltage is too high. 2. Motor is driven by external forces. 3. Deceleration time is too short. 	<ol style="list-style-type: none"> 1. Reduce input voltage to normal range. 2. Eliminate external force driving or install a braking unit. 3. Reset deceleration time.

ERR04	Under-voltage fault	<ol style="list-style-type: none"> 1. Instant power-down exists in input voltage. 2. Phase loss of input power source. 3. Loose input terminals or bad contact. 	<ol style="list-style-type: none"> 1. Reset fault 2. Check input power supply 3. Reconnect input line and make sure great contact.
ERR05	Input phase loss fault	<ol style="list-style-type: none"> 1. Input power source phase loss 2. Rectifier bridge or charge resistance damage 	<ol style="list-style-type: none"> 1. Check input power source and connection 2. Seek for technical support.
ERR06	Phase loss fault	<ol style="list-style-type: none"> 1. Loose connected wire of frequency inverter and motor. 2. Motor damage 	<ol style="list-style-type: none"> 1. Check connected wire of frequency inverter and motor 2. Measure three-phase output of frequency inverter in the situation of without motor. If output is balanced ,motor has been damaged.
ERR07	Frequency inverter overload	<ol style="list-style-type: none"> 1. Accelerate/Decelerate time is too short. 2. Boost setting of V/F torque is too large 3. Load is too heavy 	<ol style="list-style-type: none"> 1. Reset accelerate/decelerate time 2. Reset the boost value of torque 3. Decrease the load or replace matched frequency inverter
ERR08	Motor overload	<ol style="list-style-type: none"> 1. Parameter setting of motor protection is unreasonable. 2. Load suddenly increases or motor is locked-rotor. 3. Frequency inverter's capacity is small 	<ol style="list-style-type: none"> 1. Reset motor's protection parameter 2. Decrease load or solve the problem of locked-rotor 3. Choose the frequency inverter which has greater power
ERR09	Overheating fault	<ol style="list-style-type: none"> 1. Ambient temperature is too high. 2. Poor ventilation in inverter. 3. Damaged fan. 4. Damaged temperature sensor. 	<ol style="list-style-type: none"> 1. Check if ambient temperature meets requirements. 2. Improve ventilation of inverter. 3. Replace a fan. 4. Replace a temperature sensor
ERR10	PTC Disconnection fault	<ol style="list-style-type: none"> 1. Temperature sensor damage 2. Terminal has bad contact 	<ol style="list-style-type: none"> 1. Replace temperature sensor 2. Reinsert the terminal
ERR11	Soft enablement fault	<ol style="list-style-type: none"> 1. Input voltage is too low 2. Frequency inverter rectification circuit fault 	<ol style="list-style-type: none"> 1. Check the input voltage if correspond with the demands. 2. Seek for technical support
ERR12	External fault	<ol style="list-style-type: none"> 1. External fault terminal action 	<ol style="list-style-type: none"> 1. Check external equipment
ERR13	Communication overtime fault	<ol style="list-style-type: none"> 1. Parameter setting of communication is unreasonable 2. Communication circuit fault 	<ol style="list-style-type: none"> 1. Reset PID parameter,P08.XX 2. Check communication circuit

ERR14	PID feedback disconnection	<ol style="list-style-type: none"> 1. Improper PID parameter setting 2. PID feedback circuit has a fault. 	<ol style="list-style-type: none"> 1. Reset PID parameters, P10.XX 2. Examine PID feedback loop.
ERR15	Memory fault	<ol style="list-style-type: none"> 1. The chip of memory damage. 2. Strong interference causes read-write wrong 	<ol style="list-style-type: none"> 1. Seek technical support. 2. Retry after reset failure.
ERR16	Motor tuning cancelation	<ol style="list-style-type: none"> 1. Press STOP button during parameter self-identification process 	<ol style="list-style-type: none"> 1. Retry after fault reset.
ERR17	Stator resistance abnormal	<ol style="list-style-type: none"> 1. Motor disconnects with output terminal of frequency 2. Motor is no-load 3. Motor damages 	<ol style="list-style-type: none"> 1. Check the connection of frequency and motor 2. Break motor' s load 3. Check motor
ERR18	No-load current fault	<ol style="list-style-type: none"> 1. Motor disconnects with output terminal of frequency 2. Motor is no-load 3. Motor damages 	<ol style="list-style-type: none"> 1. Check the connection of frequency and motor 2. Break motor' s load 3. Check motor
ERR19	Timed locking machine	<ol style="list-style-type: none"> 1. Frequency inverter running time arrival 	<ol style="list-style-type: none"> 1. Seek for technical support.

7

7.2 Fault record inquiry

ES100A series compact vectorial inverter provides recent 3 fault information records. User can inquire 3 recent fault codes and last time fault' s output frequency, output current and busbar voltage by referring to group P14. xx parameters. They are helpful for user to judge and eliminate a fault.

7.3 Fault reset

When ES100A series compact vectorial inverter has a fault, in order to quit fault alarm status, press ESC key to reset the fault after eliminating the cause of fault; if the fault is not cleared, inverter will stay in fault state and keypad display continues to show fault code.

Chapter 8 Electromagnetic compatibility guidance

8.1 Definition

Electromagnetic compatibility is the ability of electrical equipment to coexist in such conditions as finite space, time and spectrum resources without degrading performance. In this case, equipment, subsystem and system should not exceed required of electromagnetic emission by regulation and standard and should meet immunity need.

8.2 EMC standard introduction

According to GB/T12668.3, the frequency inverter should satisfy the requirement of two aspects. One is electromagnetic interference and the other is anti-electromagnetic interference.

Our company now implements the latest international standard IEC/EN61800-3: 2004 (Adjustable speed electrical power drive systems part 3: EMC requirements and specific test methods)

IEC/EN61800-3 mainly examines the frequency inverter in two aspects. One is electromagnetic interference and the other is anti-electromagnetic interference. About electromagnetic interference, it mainly tests the frequency inverter in radiated interference, conducted interference and harmonic interference. (There is a corresponding rule for civil frequency inverters). About anti-electromagnetic interference, it mainly tests the frequency inverter in conducted immunity, radiated immunity, surge immunity, fast transient-burst immunity, ESD immunity and power supply's low frequency immunity. The following are specific test items: 1. Immunity test of input voltage's sag, interruption and change; 2. Immunity test of commutation notch; 3. Immunity test of harmonic input; 4. test of input frequency change; 5. test of input voltage's imbalance; 6. test of input voltage's vibration. We will carry out tests according to IEC/EN61800-3's strict rules. Our company's products will be installed and used according to the instructions in 8.3 so that they possess good electromagnetic compatibility in the normal industrial environment.

8.3 EMC Guidance

8.3.1 Harmonic's influence

Power supply's high-order harmonic may cause damage to the frequency inverter itself or its peripheral electrical equipment. In a place where power quality is fairly poor, we suggest that an AC input electric reactor or a current harmonic filter is installed. Because of the harmonics, choosing the residual current circuit breaker should refer to the description of main circuit input side's wiring.

Current of the cables with the frequency inverter's motor power has high-order harmonics. Therefore, resonance may lead to thermal relay's malfunction. In this case, carrier frequency needs to decrease or an electric reactor needs to be installed. We suggest that users do not install a thermal reactor in front of the motor when the frequency inverter is in use. Instead, users should employ the over current protection function.

8.3.2 Electromagnetic interference and installation precautions

1. Frequency inverter and other electric products should be well grounded. When using the EMC filter, users must use permanently-fixed ground joint. This kind of joints doesn't need connector's transfer.
2. Users had better lay out the frequency inverter's input, motor's power cable and weak electric signal lines (the control signal cable for example) separately. If possible, the weak electric signal line should be laid out separately in the metal cabling channel.
3. Frequency inverter's input and motor's power cables are advised to employ shielded cables or armored cables. Cable's two ends' shielding layer or armor should be firmly grounded. As for the weak electric signal line susceptible to interferences, we suggest that users employ the shielded twisted pair and ground the shielding layer firmly.
4. If the motor cable's length is over 50m, an output filter or a reactor is required to be installed.

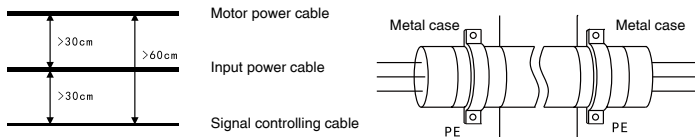

Figure 8-1 Wiring requirements and shield earthing method

8.3.3 Earthing

1. Frequency inverter and other equipment are advised to be earthed separately. If a common ground point is needed, they should be employed single point earthing method. Common ground line is not suggested.
2. Users had better employ the earthing cable with a large section to make sure that ground impedance is as low as possible. As for cables with the same sectional area, those with flat conductors have lower high-frequency impedance than those with round conductors. Therefore, the flat cable is a better choice. Earthing cables should be as short as possible and the ground point should be as near the frequency inverter as possible.
3. Motor power cables should be 4-core cables. The 4-core cable's ground wire should earth on the frequency inverter's one side. And the other side should be connected to the motor's earthing end. If the motor and the frequency inverter have their separate dedicated ground point, the earthing can get the best results.
4. If all components' earthing ends in the control system are earthed to the same point, the earth leakage current will produce noise source, which will influence other peripheral equipment except for the frequency inverter in the control system. Thus in the same control system, the frequency inverter and such weak equipment as the computer, the sensors and audio devices must be earthed separately.
5. To get relatively low high-frequency impedance, users can use each equipment's fixed bolts as the high-frequency terminals connected to the cabinet's rear panel. Please remember to remove the fixed point's insulating varnish.
6. When users lay out the earthing cable, the cable should be far away from the wire of noise-sensitive equipment I/O and users need to pay attention to the earthing wire and make it as short as possible.

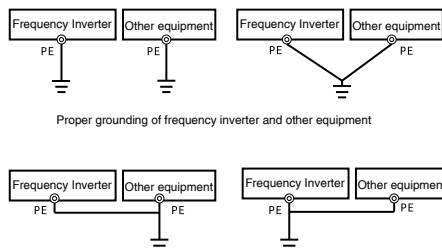

Figure 8-2 Not recommended grounding methods of inverter and other equipments

8.3.4 Solutions of peripheral electric equipment causing electromagnetic interferences to the frequency inverter.

The relay, contactor, electromagnetic brake and other equipment in the peripheral environment may cause electromagnetic interferences. When there is malfunction due to the electromagnetic interferences, solutions are as follows:

1. Install surge suppressors on the items which have caused the interferences;
2. Install an EMC filter on the frequency inverter's input power cable. The procedures will be introduced later;
3. Frequency inverter's control signals' wires and inspection wire should be shield wires or twisted-pair wires. Shield layers of the shield wires should be firmly earthed (Earthed in a circle of 360 degrees).

8.3.5 Solutions of the frequency inverter causing electromagnetic interferences to peripheral equipment.

There are two kinds of interferences the frequency inverter can cause to peripheral equipment. One is conducted interference and the other is radiated interference. For different kind of interference, solutions in the following part are for users' reference:

1. Instruments, equipment, receivers and sensors for measurement often produce weak electrical signals. If they are near the frequency inverter or are in the same control cabinet with the frequency inverter, there may easily be interferences and halation. Weak electrical signals are advised to be as far away from interference source as possible; Don't bundle the weak electrical signals with power cables; Signal wires should be shield wires or twisted-pair wires and shield layers of the shield wires should be firmly earthed (earthed in a circle of 360 degrees); Add ferrite rings to the power cables (ferrite rings are Nickel-Zinc rings with blanketing frequency of over 30MHz) and wrap the cables for 2-3 turns. To get better results, users can use EMC filter.
2. When the equipment affected by interferences and the frequency inverter gets power from the same power supply, conducted interferences will easily occur. We suggest that EMC filter is installed in the frequency inverter's input terminal. The specific procedures will be introduced in the last section of the chapter;
3. Peripheral equipment should be earthed alone to reduce the common-mode interferences caused by common-ground impedance.

8.3.6 Leakage current and the solution

There exist distributed capacitances between the power cables and the earth. The longer the power cable is, the larger the distributed capacitances are and the higher the leakage current is; The higher the carrier frequency is, the higher the leakage current is. Shortening the length of the power cable and decreasing carrier frequency can reduce the leakage current. However, decreasing carrier frequency can result in more motor noise. Therefore, users need to strike a balance between reducing the leakage current and increasing the motor noise.

8.3.7 Precautions of installing EMC filter to the power supply's input end

1. When using the filter, please use it according to the rated value strictly; The filter falls in the category of I type electric appliance, thus its metal case must connect to the installation cabinet's metal ground well in a large area. Apart from that, the metal case is also required of possessing fine earthing continuity. Otherwise, there may be an electrical shock and EMC's effect will be greatly influenced.
2. The filter and the frequency inverter's PE end must be earthed to a common ground. Otherwise, EMC's effect will be greatly influenced.
3. Inside the cabinet, the filter should be installed as near the input power cable's input end as possible and the filter's power input wire should be as short as possible in the control cabinet.
4. If the filter's input wires and output wires are laid out too close to each other, high-frequency interferences will bypass the filter. Coupling directly through the filter's input wires and output wires will make the power supply filter ineffective.
5. There is always a dedicated earthing terminal on the filter's case. However, if one wire is used to connect the filter to the control cabinet's case, high-frequency interferences will not be reduced. This is because long wires' high-frequency impedance is too large to bypass the high-frequency interferences. The correct installation method is to stick a large area of the filter's case to the metal shell's conducting plane. Please remember to remove the insulating varnish when installing and make sure it is connected safely.

Chapter 9 Specifications of Optional Accessories

9.1 Specifications of Braking Resistor Matching

ES100A Vector Compacted Series's whole series provide the users with built-in braking units. Users can choose different braking resistance values and different power according to the actual conditions. However, resistance values cannot be smaller than the recommended values in Chart9-1 while users may choose higher resistance power than the recommended. Choosing the braking resistor depends on motor's generated power in the actual application system. It is related to such items as system's inertia, deceleration time and load energy. Therefore, users need to make the choice according to the actual conditions. The greater inertia, the shorter deceleration time needed and the more frequent braking will need the braking resistor with higher power and smaller resistance.

Table9-1 ES100A Vector Compacted Series brake resistance sizing table

Frequency inverter's type	Recommended power of Braking Resistor	Recommended resistance of Braking Resistor
DRS ES100A-2S-0R4G	≥ 100W	≥ 360Ω
DRS ES100A-2S-0R7G	≥ 200W	≥ 180Ω
DRS ES100A-2S-1R5G	≥ 200W	≥ 180Ω
DRS ES100A-2S-2R2G	≥ 400W	≥ 90Ω
DRS ES100A-2S-0R4G-M	≥ 100W	≥ 360Ω
DRS ES100A-2S-0R7G-M	≥ 200W	≥ 180Ω
DRS ES100A-2S-1R5G-M	≥ 200W	≥ 180Ω
DRS ES100A-2S-2R2G-M	≥ 400W	≥ 90Ω
DRS ES100A-2S-4R0G	≥ 780W	≥ 75Ω
DRS ES100A-2T-0R4G	≥ 100W	≥ 360Ω
DRS ES100A-2T-0R7G	≥ 200W	≥ 180Ω
DRS ES100A-2T-1R5G	≥ 200W	≥ 180Ω
DRS ES100A-2T-2R2G	≥ 400W	≥ 90Ω
DRS ES100A-2T-0R4G-M	≥ 100W	≥ 360Ω
DRS ES100A-2T-0R7G-M	≥ 200W	≥ 180Ω
DRS ES100A-2T-1R5G-M	≥ 200W	≥ 180Ω
DRS ES100A-2T-2R2G-M	≥ 400W	≥ 90Ω
DRS ES100A-2T-4R0G	≥ 780W	≥ 75Ω
DRS ES100A-2T-5R5G	≥ 1200W	≥ 50Ω
DRS ES100A-2T-7R5G	≥ 1500W	≥ 40Ω
DRS ES100A-2T-011G	≥ 2200W	≥ 28Ω
DRS ES100A-2T-015G	≥ 3000W	≥ 24Ω
DRS ES100A-2T-018G	≥ 3700W	≥ 20Ω
DRS ES100A-2T-022G	≥ 4500W	≥ 16Ω
DRS ES100A-2T-030G	≥ 5500W	≥ 13Ω

DRS ES100A-2T-037G	≥ 7500W	≥ 9Ω
DRS ES100A-2T-045G	≥ 9300W	≥ 6.8Ω
DRS ES100A-2T-055G	≥ 11000W	≥ 6.2Ω
DRS ES100A-2T-075G	≥ 13000W	≥ 4.7Ω
DRS ES100A-2T-090G	≥ 15000W	≥ 3.9Ω
DRS ES100A-3T-0R7G	≥ 200W	≥ 360Ω
DRS ES100A-3T-1R5G	≥ 400W	≥ 180Ω
DRS ES100A-3T-2R2G	≥ 400W	≥ 180Ω
DRS ES100A-3T-4R0G	≥ 800W	≥ 90Ω
DRS ES100A-3T-0R7G-M	≥ 200W	≥ 360Ω
DRS ES100A-3T-1R5G-M	≥ 400W	≥ 180Ω
DRS ES100A-3T-2R2G-M	≥ 400W	≥ 180Ω
DRS ES100A-3T-4R0G-M	≥ 800W	≥ 90Ω
DRS ES100A-3T-5R5G	≥ 1000W	≥ 60Ω
DRS ES100A-3T-7R5G	≥ 1000W	≥ 60Ω
DRS ES100A-3T-011G	≥ 2000W	≥ 30Ω
DRS ES100A-3T-015G	≥ 2000W	≥ 30Ω
DRS ES100A-3T-018G	≥ 2100W	≥ 29Ω
DRS ES100A-3T-022G	≥ 2200W	≥ 28Ω
DRS ES100A-3T-030G	≥ 3000W	≥ 24Ω
DRS ES100A-3T-037G	≥ 3700W	≥ 20Ω
DRS ES100A-3T-045G	≥ 4500W	≥ 16Ω
DRS ES100A-3T-055G	≥ 5500W	≥ 13Ω
DRS ES100A-3T-075G	≥ 7500W	≥ 9Ω
DRS ES100A-3T-090G	≥ 9300W	≥ 6.8Ω
DRS ES100A-3T-110G	≥ 11000W	≥ 6.2Ω
DRS ES100A-3T-132G	≥ 13000W	≥ 4.7Ω
DRS ES100A-3T-160G	≥ 15000W	≥ 3.9Ω

Caution: When connecting the braking resistor's wires, users should choose cables with withstand voltage over AC450V and tolerable temperature of 105°C .

Appendix A ModBus Communication Protocol

1 Overview

ES100A Vector Compacted Series whole series provide users with RS485 serial communication interface and employ MODBUS communication protocol. Through the computer or PLC, users can achieve centralized control, set the frequency inverter's running commands, modify or read the function code's parameters, read the frequency inverter's working state and fault information. What's more, the computer or PLC can function as the master machine, which can make it convenient for multiple frequency inverters to run at the same time.

2 Serial Port Data Format

Through P07 group of communication parameters, users can set the corresponding communication parameters.

Local address: can be set as 1~247 (cannot conflict with other equipment using the network). When the address is 0, it is the broadcast address. Communication baud rate: can choose as 4800,9600,19200 or 38400bps.

Local address: can be set as 1~247 (cannot conflict with other equipment using the network). When the address is 0, it is the broadcast address. Communication baud rate: can choose as 4800,9600,19200 or 38400bps.

Communication format: can choose to be No check 1+8+1;
Even parity check 1+8+1+1;
Odd parity check 1+8+1+1;

3 Protocol Frame Format

Start of frame \geq 3.5 Character time Intervals	Slave machine's (1byte)	Function codes (1byte)	Data (Nbyte)	CRC16 (2byte)	End of frame \geq 3.5byte Time Intervals
--	---------------------------------	--------------------------------	-------------------	------------------	--

4 Function Codes of the ES100A Serial Frequency Inverter

ES100A Vector Compacted Series altogether supports 4 kinds of MODBUS-RTU function codes. Function code: 0x03 Register multiple read operation could read at most 8 function codes continuously.

Example1 Master Machine output frame: Read NO.10 (0AH) frequency inverter's input and output frequency, which is the initial 2 byte of contents when the register's address is 0D00H.

Byte order	Data meaning	Data value
1	Slave machine's address	0AH
2	MODBUS function number	03H
3	Access address (high byte)	0DH
4	Word number read (low byte)	00H
5	Word number read (high byte)	00H
6	Word number read (low byte)	02H
7	CRC (low byte)	C7H
8	CRC (high byte)	DCH

Slave machine return frame: No 10 frequency inverter's operation is successful with the return frequency 50.00Hz and the output frequency 50.00Hz.

Byte order	Data meaning	Data value
1	Slave machine's address	0AH
2	MODBUS function number	03H
3	Return Byte Count	04H
4	0D00 content's high byte	13H
5	0D00 content's low byte	88H
6	0D01 content's high byte	13H
7	0D01 content's low byte	88H
8	CRC (low byte)	C9H
9	CRC (high byte)	0BH

Function code: 0x06 a single register writes operation and one function code at a time.

Example 2: Main machine transmit frame: Set the No 10(0AH) frequency inverter's acceleration time 1 (P00.11) to be 15.00S. It means the register writes 05DCH in 000BH address.

Byte order	Data meaning	Data value
1	Slave machine's address	0AH
2	MODBUS function number	06H
3	Access address (high byte)	00H
4	Access address (low byte)	0BH
5	Data written (high byte)	05H
6	Data written (low byte)	DCH
7	CRC (low byte)	FBH
8	CRC (high byte)	BAH

Slave machine return frame: No 10 frequency inverter's operation is successful with the return acceleration time1 (P00.11) 15.00S.

Byte order	Data meaning	Data value
1	Slave machine's address	0AH
2	MODBUS function number	06H
3	Access address (high byte)	00H
4	Access address (low byte)	0BH
5	Data written (high byte)	05H
6	Data written (low byte)	DCH
7	CRC (low byte)	FBH
8	CRC (high byte)	BAH

Function code: 0x10 Register multiple write operation can write at most 8 function codes continuously.

Example 3 Main machine transmit frame: Set the No 10(0AH) frequency inverter's acceleration time 2 (P06.03) and deceleration time2 (P06.04) to be 15.00S.It means two registers starting from 0603H both write 05DCH.

Byte order	Data meaning	Data value
1	Slave machine's address	0AH
2	MODBUS function number	10H
3	Access address (high byte)	06H
4	Access address (low byte)	03H
5	Register quantity (high byte)	00H
6	Register quantity (low byte)	02H
7	Data written number of bytes	04H
8	The first data (high byte)	05H
9	The first data (low byte)	DCH
10	The second data (high byte)	05H
11	The second data (low byte)	DCH
12	CRC (low byte)	7EH
13	CRC (high byte)	C1H

Slave machine return frame: No 10 frequency inverter's operation is successful and return to operate the register's initial address and the register's number.

Byte order	Data meaning	Data value
1	Slave machine's address	0AH
2	MODBUS function number	10H
3	Access address (high byte)	06H
4	Access address (low byte)	03H
5	Number of registers (high byte)	00H
6	Number of registers (low byte)	02H
7	CRC (low byte)	B0H
8	CRC (high byte)	3BH

Function code: 0x08 circuit diagnosis tests will be used to detect the serial port's fault and require that the frame return as it is. Master machine transmit frame and slave machine return frame are as follows (assuming that No 10 Frequency inverter is tested):

Byte order	Data meaning	Data value
1	Slave machine's address	0AH
2	MODBUS function number	08H
3	Code for tes (high byte)	00H
4	Code for tes (low byte)	00H
5	Data for test (high byte)	22H
6	Data for test (low byte)	02H
7	CRC (low byte)	78H
8	CRC (high byte)	11H

5 Communication Register's Mapping Scope

ES 100A serial frequency inverter increases EEPROM's life and reliability to avoid EEPROM's frequent being read and written. Apart from the 2 corresponding pieces of storage space aimed for all parameters' function codes, there are two additional dedicated registers.

Register	Mapping address	FUNCTIONAL DESCRIPTION
Parameter code (EEPROM)	0000H~0E05H	Developed in EEPROM. Mappings of the corresponding parameters' function codes. High byte corresponding bit is parameter's function group while low byte corresponding bit is parameter's function code. For example, P00.05 communication address is high-order 00H and low-order 05H, which means that the mapping address is 0005H. P13.17 communication address is high-order 0DH and low-order 11H, which means that the mapping address is 0D11H.
Parameter code (RAM)	2000H~2E05H	Developed in RAM. Mappings of the corresponding parameters' function codes. High byte corresponding bit is parameter's function group while low byte corresponding bit is parameter's function code. For example, P00.05 communication address is high-order 20H and low-order 05H, which means that the mapping address is 2005H. P13.17 communication address is high-order 2DH and low-order 11H, which means that the mapping address is 2D11H.
Register special for control	4000H	Users can write the following data to the register special for control through 0x06 function and exercise the corresponding functions: 0000H:Invalid order 0001H:Operate in forward rotation 0002H:Operate in reverse rotation 0003H:Normal inching turning 0004H:Reverse inching turning 0005H:Slave machine stops 0006H:Stop by deceleration 0007H:Free stop 0008H:Fault reset 0009H:Positive and negative input switch 000AH:Reservation 000BH:Reservation
Register special for state	4100H	Users can read the data of register special for state through 0x03 function to know about the frequency inverter's working state: 0000H:Parameter setting 0001H:Slave machine running 0002H:Inching running 0003H:Self-recognized running 0004H:Slave machine stops 0005H:Inching stop 0006H:Fault state 0007H:Frequency inverter's self-checking

6 Communication faults

When the frequency inverter's slave machine cannot respond to the command sent from the master machine, exceptional response frame will return and its format is as follows (assuming that the slave machine is No.10 frequency inverter):

Byte order	Data meaning	Data value
1	Slave machine's address	0AH
2	Response code	MODBUS function number+80H
3	Wrong code	01H: Illegal function code; 02H: Illegal data address; 03H: Illegal data; 04H: Slave machine's unsuccessful operation; 05H: Command valid, processing; 06H: Slave machine busy; 10H: Frame mistake; 11H: Parameter only for read; 12H: No modification during parameter's operation; 13H: The parameter is under password protection;
4	CRC (low byte)	--H
5	CRC (high byte)	--H

CRC16 的 C 语言代码:

```
unsigned short GetCRC ( unsigned char *data,unsigned short length )
```

```
{
  unsigned short j;
  unsigned short crc = 0xFFFF;
  while( length --)
  {
    crc ^= *data ++;
    for( j = 0; j < 8; j ++ )
    {
      if( crc & 0x01 )
      {
        crc = ( crc >> 1 ) ^ 0xa0001;
      }
      else
      {
        crc = crc >> 1;
      }
    }
  }
  return ( crc );
}
```



SHENZHEN DIRISE ELECTRIC TECHNOLOGY CO., LTD

R & D Center: Room 0411, Building 6, Skyworth Innovation Valley, Baoan District, Shenzhen.

Shenzhen switchboard: 0755-2605 2805

Http: <http://www.dirise.cn>

DONGGUAN DIRISE ELECTRIC EQUIPMENT MANUFACTURING CO.,LTD

production base: No.11 SangYuan Road, ChenWu Village, HouJie Town, DongGuan City

Dongguan switchboard: 0769-8588 7800

Http: <http://www.dirise.cn>